

Git

Sébastien Cevey <seb@ciné7.net>

GULL (31 mars 2008)

Version Control Systems

- Historique de travail
- Travail en équipe
- Exposer le développement
- Branching

VCS centralisés

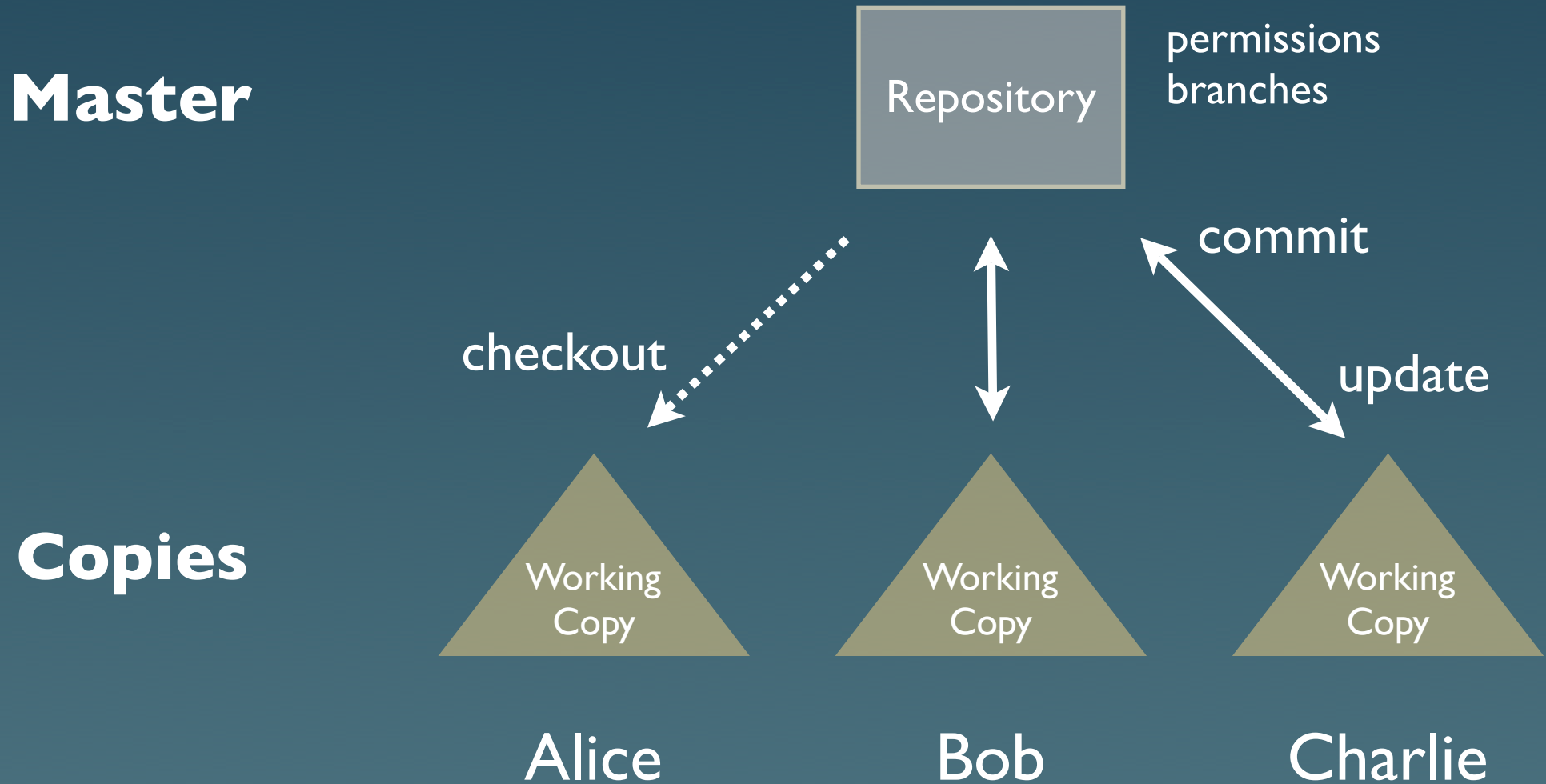

VCS décentralisés

“Tous des repositories”

“Hiérarchie libre”

offline:

- historique
- commit
- branches

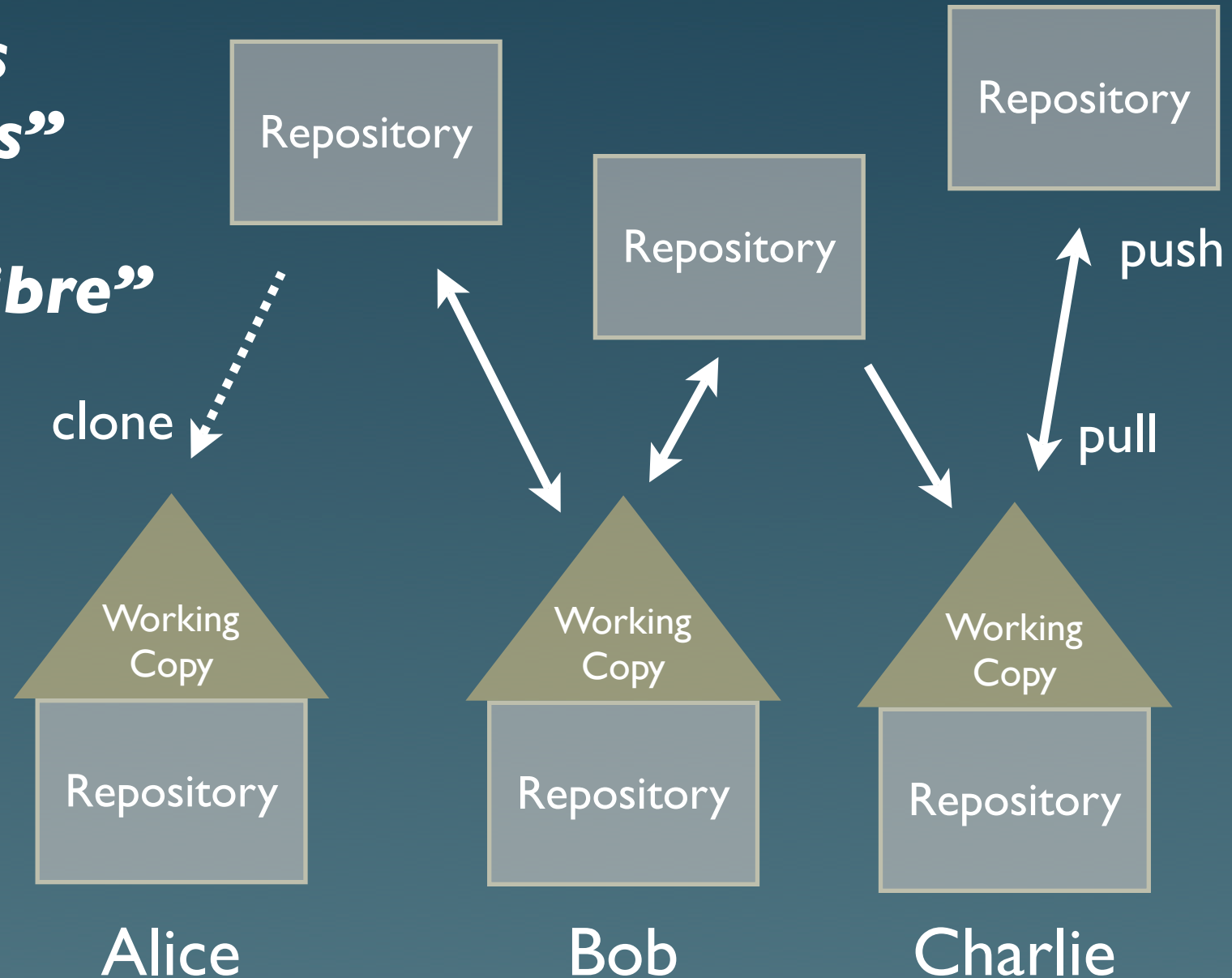

e.g. hiérarchie de XMMS2

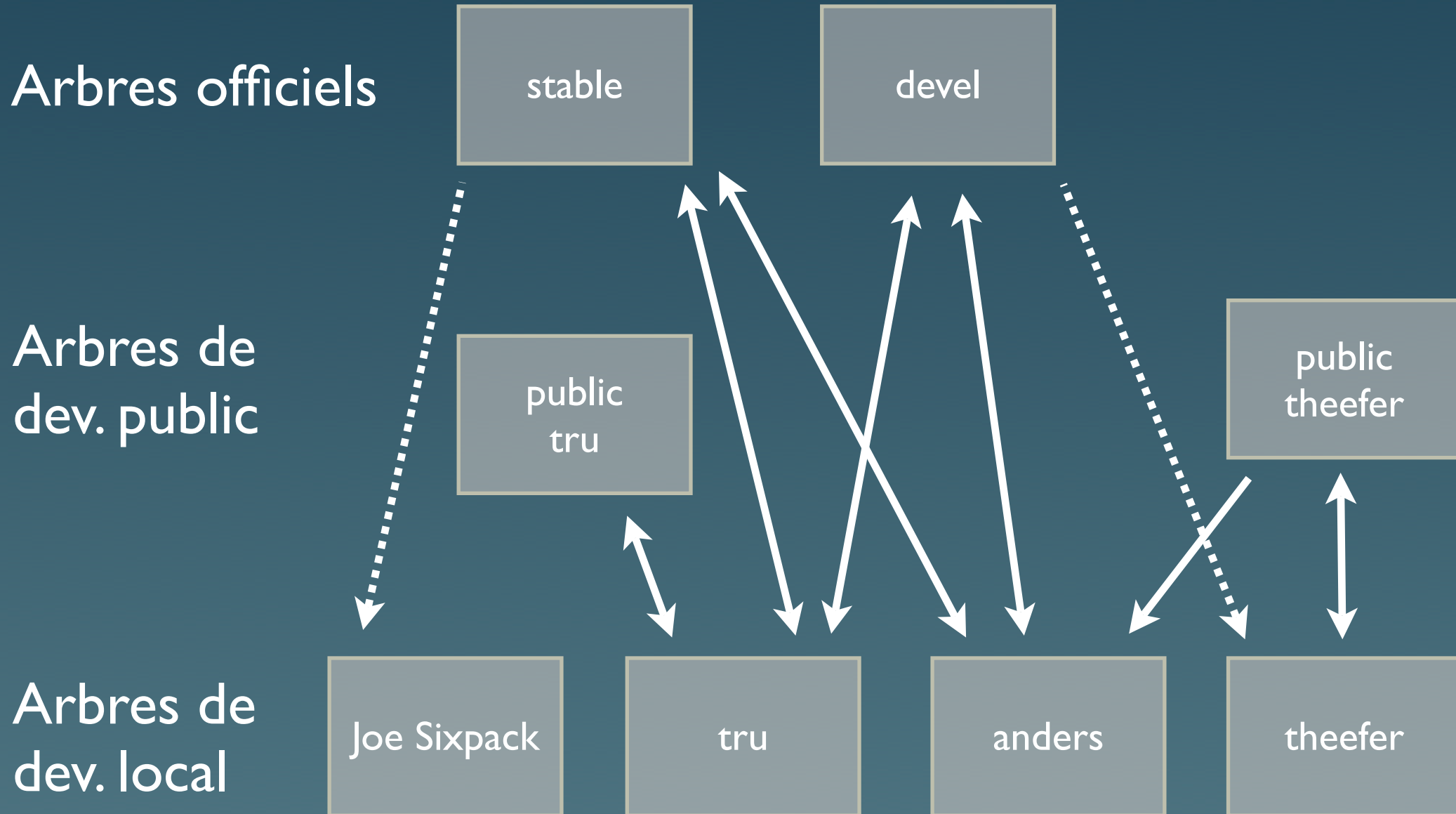

Git vs. autres DVCS

(Mercurial, Darcs, Bazaar, Arch, etc)

- + **Rapide** (exécution et mise en place)
- + Petits outils puissants (esprit Unix)
- + Développement actif
- + Linus

Git vs. autres DVCS

(Mercurial, Darcs, Bazaar, Arch, etc)

- + **Rapide** (exécution et mise en place)
- + Petits outils puissants (esprit Unix)
- + Développement actif
- + Linus
- Courbe d'apprentissage
- Pas de GUI pour grand-maman
- Linus

Concepts de Git

repository = database d'objets

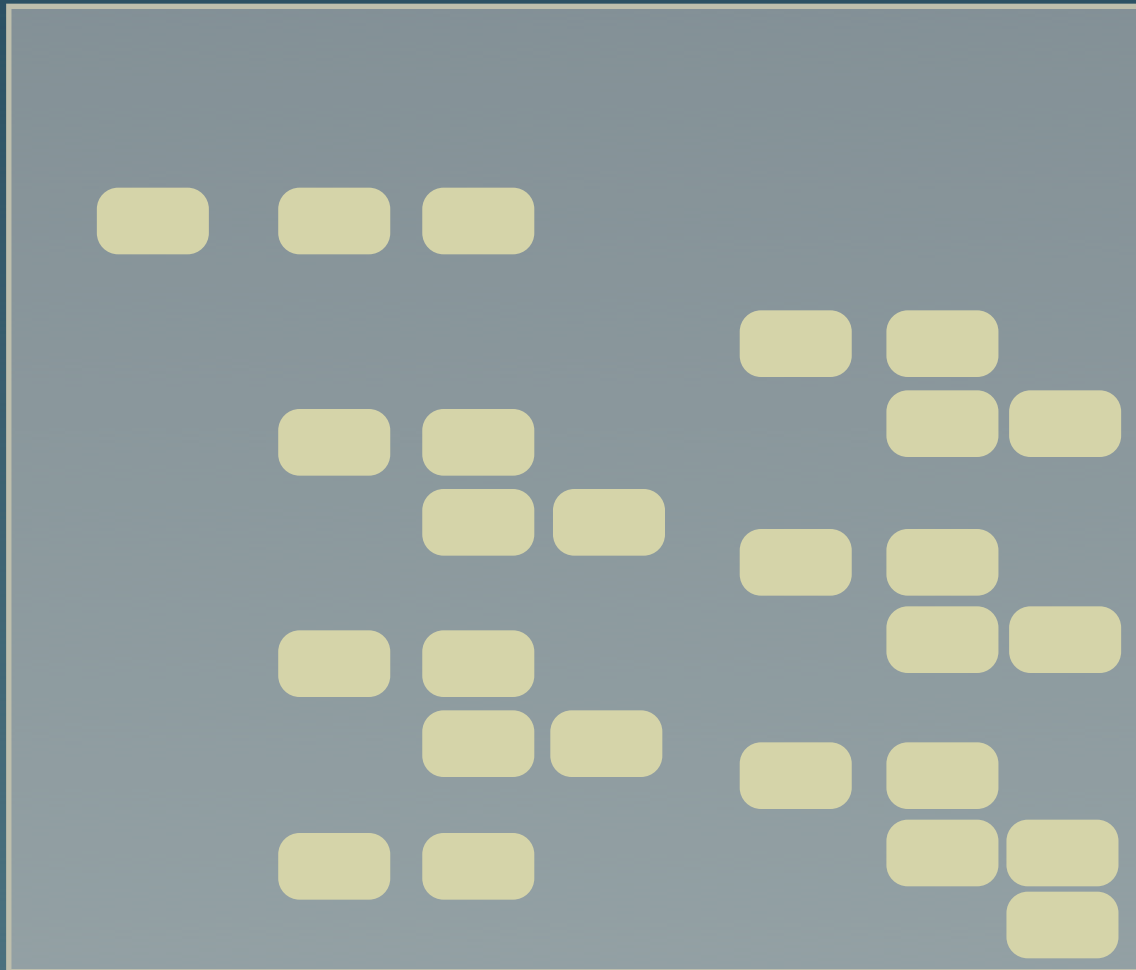

Concepts de Git

id(objet) = SHA1 (contenu de l'objet)

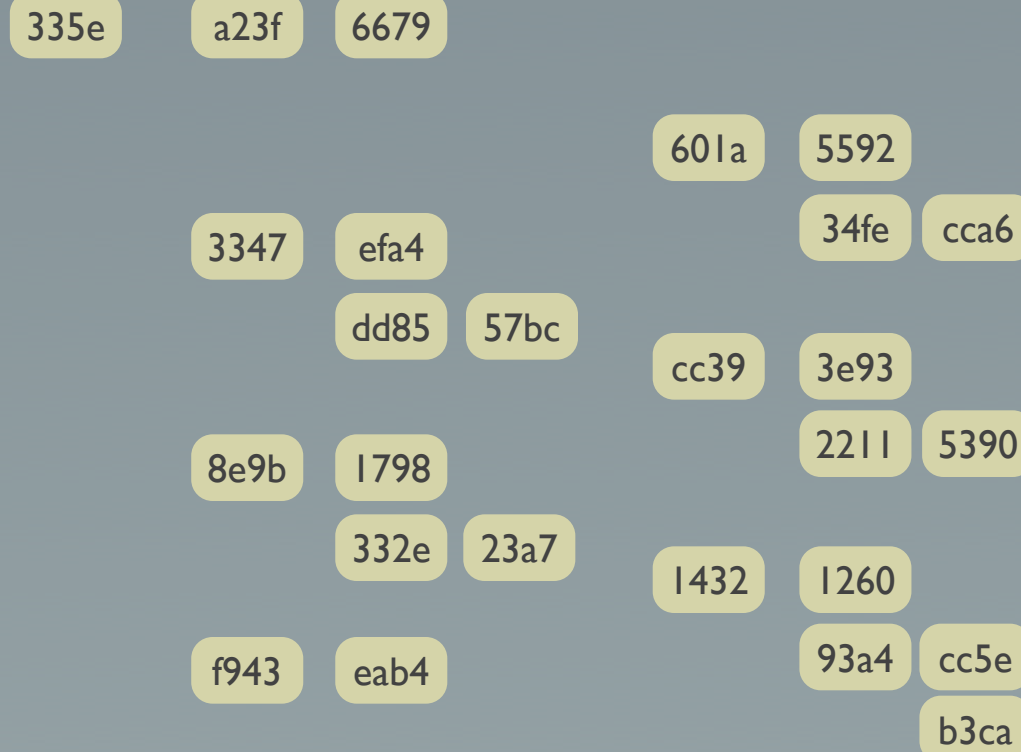

Concepts de Git

*contenu stocké dans des objets **blob***

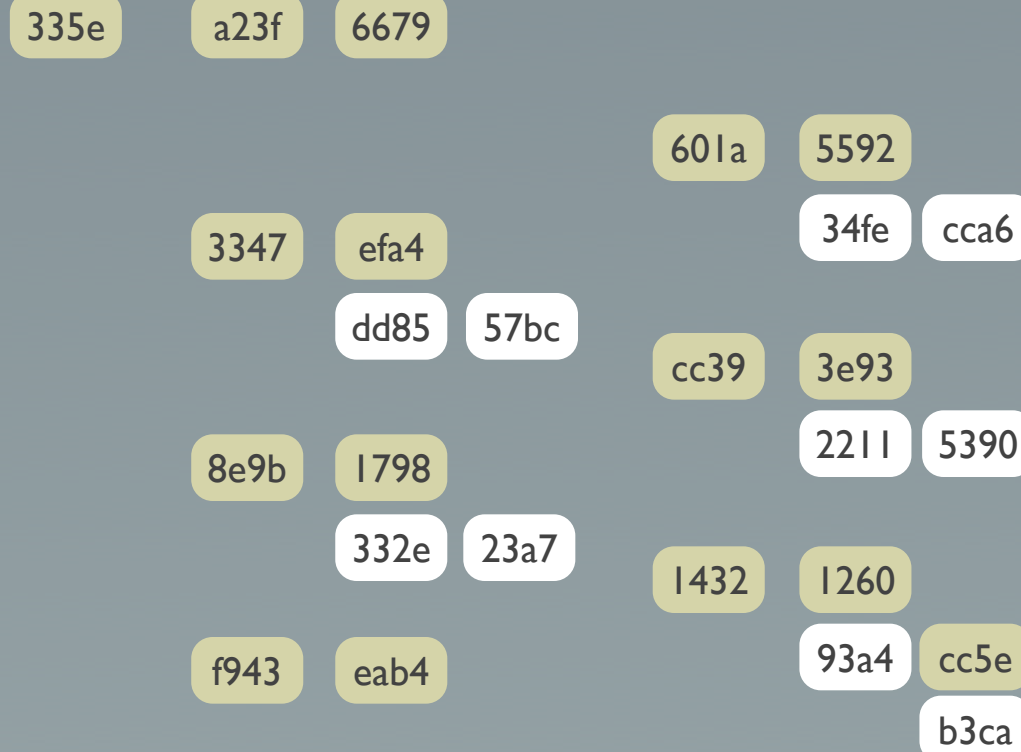

```
#include <stdio.h>

int main ()
{
    printf("Hello World");
    return 0;
}
```

Concepts de Git

*structure stockée dans des objets **tree***



```
040000 tree fec552 src
100644 blob cdea5 hw.c
100644 blob b45d5 INFO
```

Concepts de Git

historique stocké dans des objets **commit**

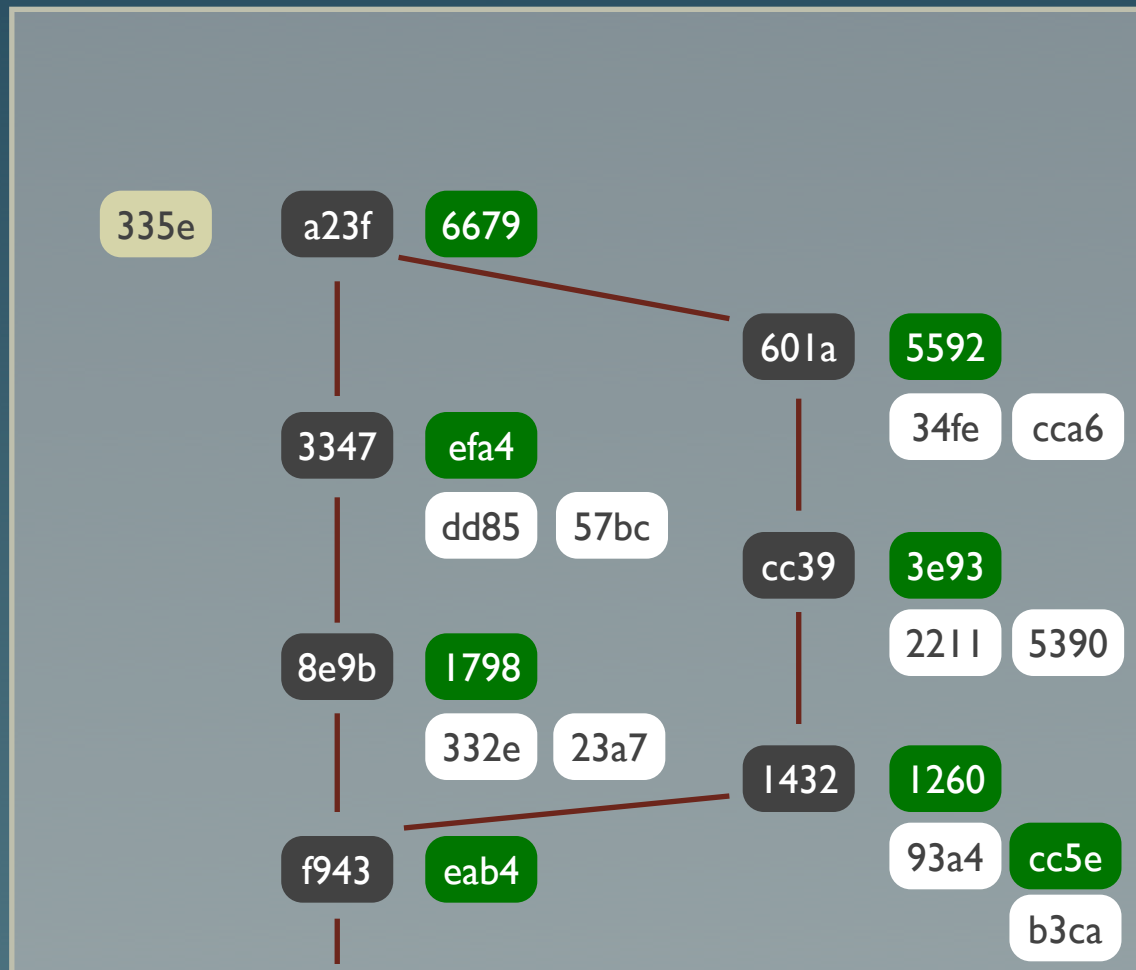

```
tree eec64...
parent c9781...
author Tom <tom@...>
 1204666883 +0100
committer Max
 <max@...>
 1204666883 +0100
```

Fixed a major bug in
Hello World.

Concepts de Git

références stockées dans des objets **tag**

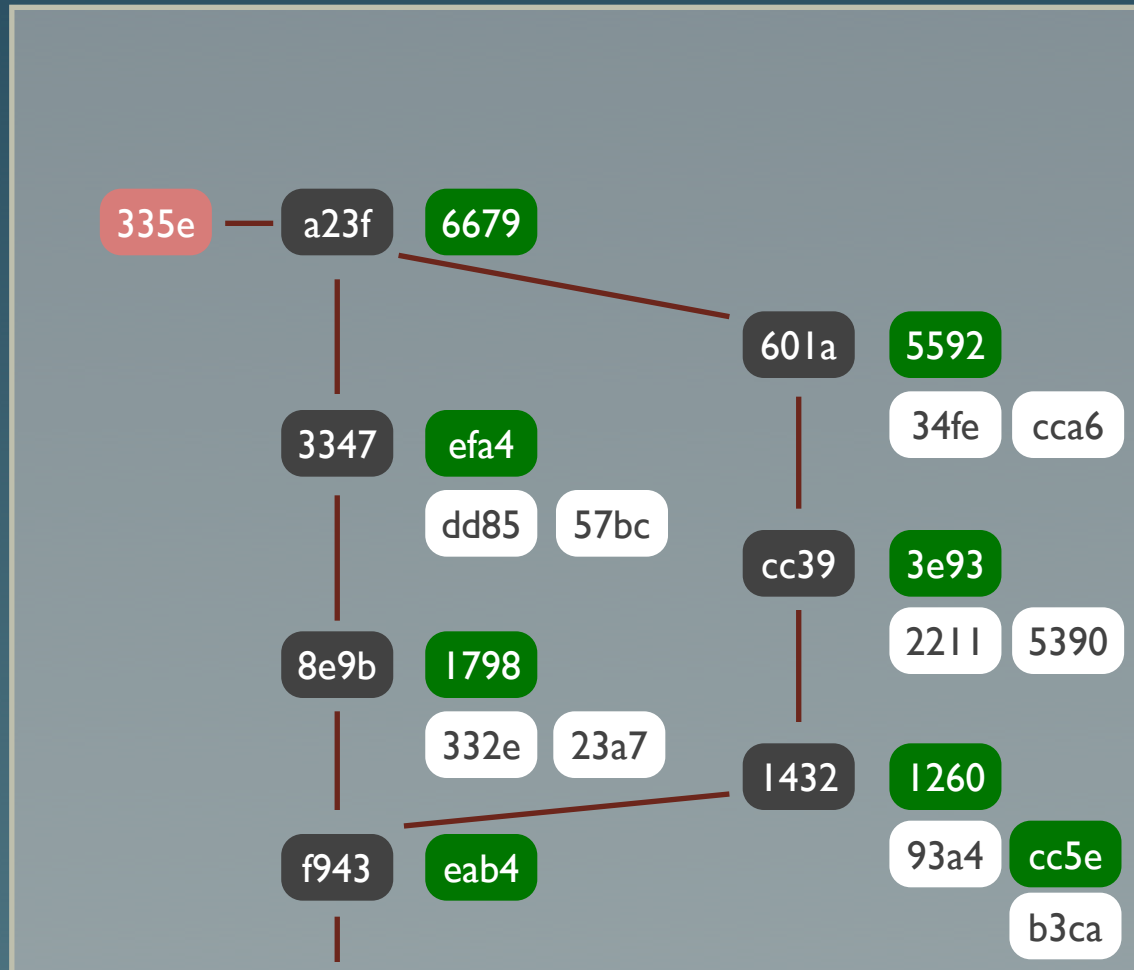

```
object 92e86...
type commit
tag v1.0.7
tagger Jack <jack@...>
      1136523576 -0800
```

```
GIT 1.0.7
-----BEGIN PGP
SIGNATURE-----
Version: GnuPG v1.4.2
(GNU/Linux)
```

```
iD8D...
-----END PGP
SIGNATURE-----
```

Concepts de Git

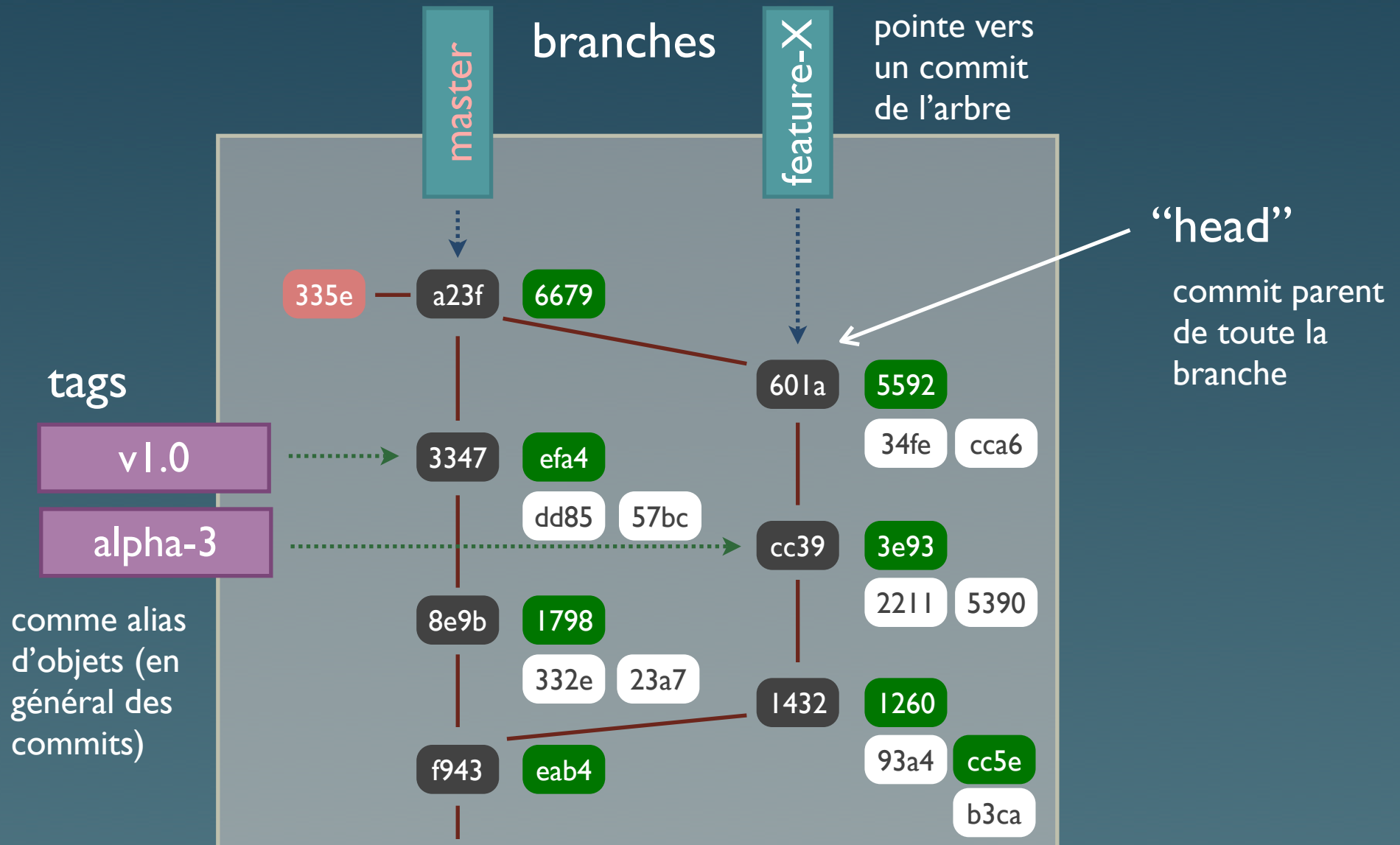

Git branches

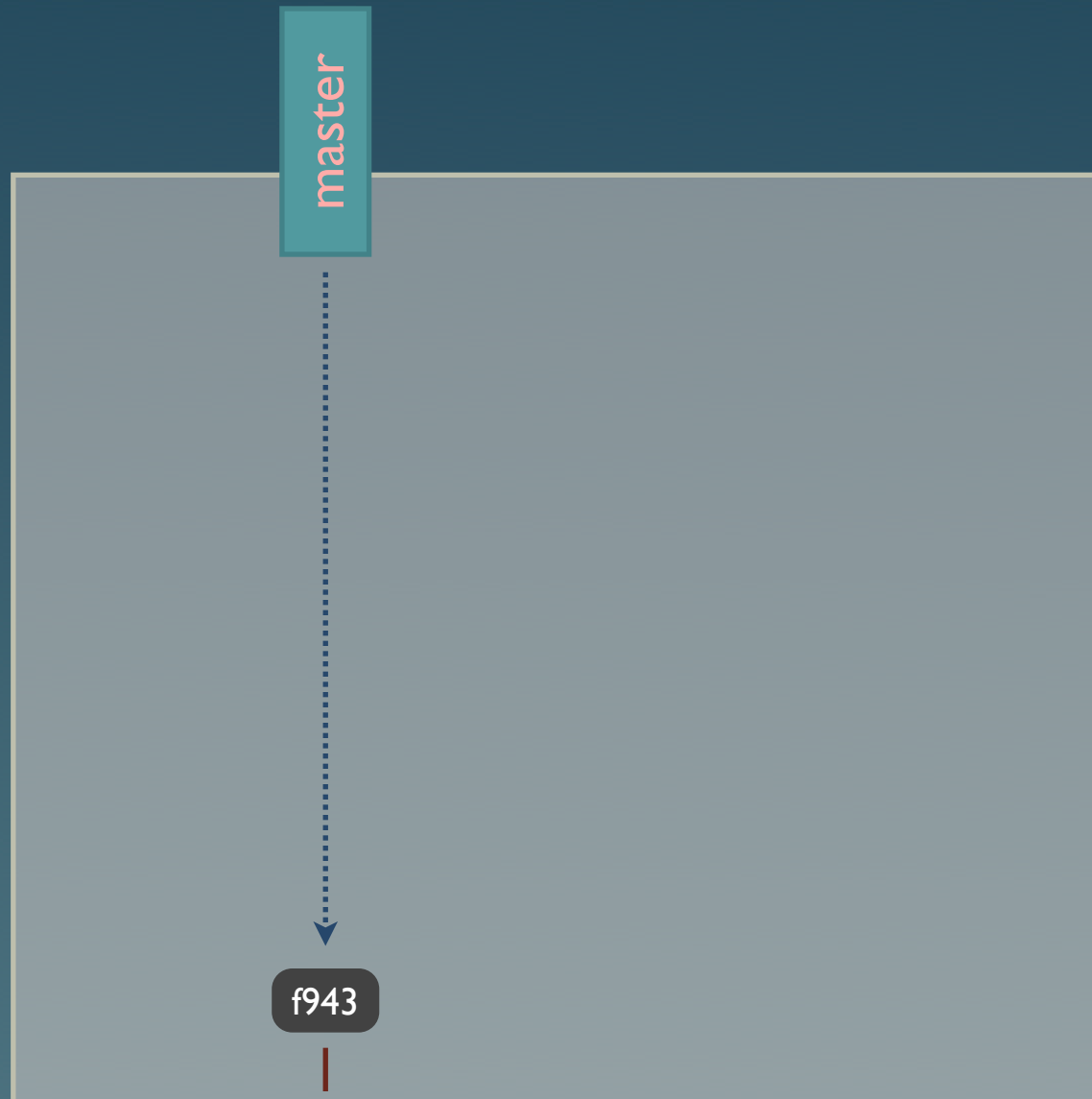

Git branches

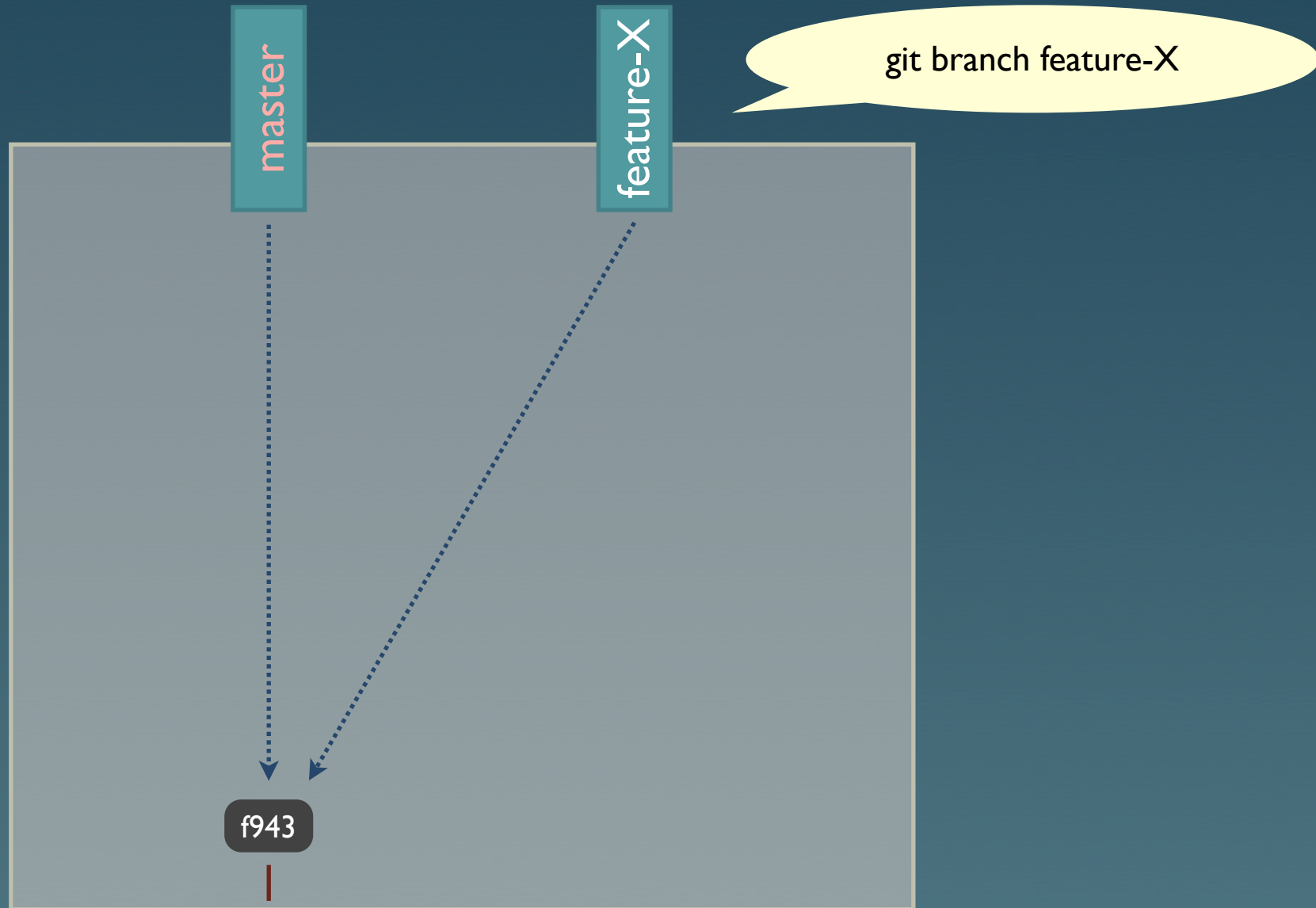

Git branches

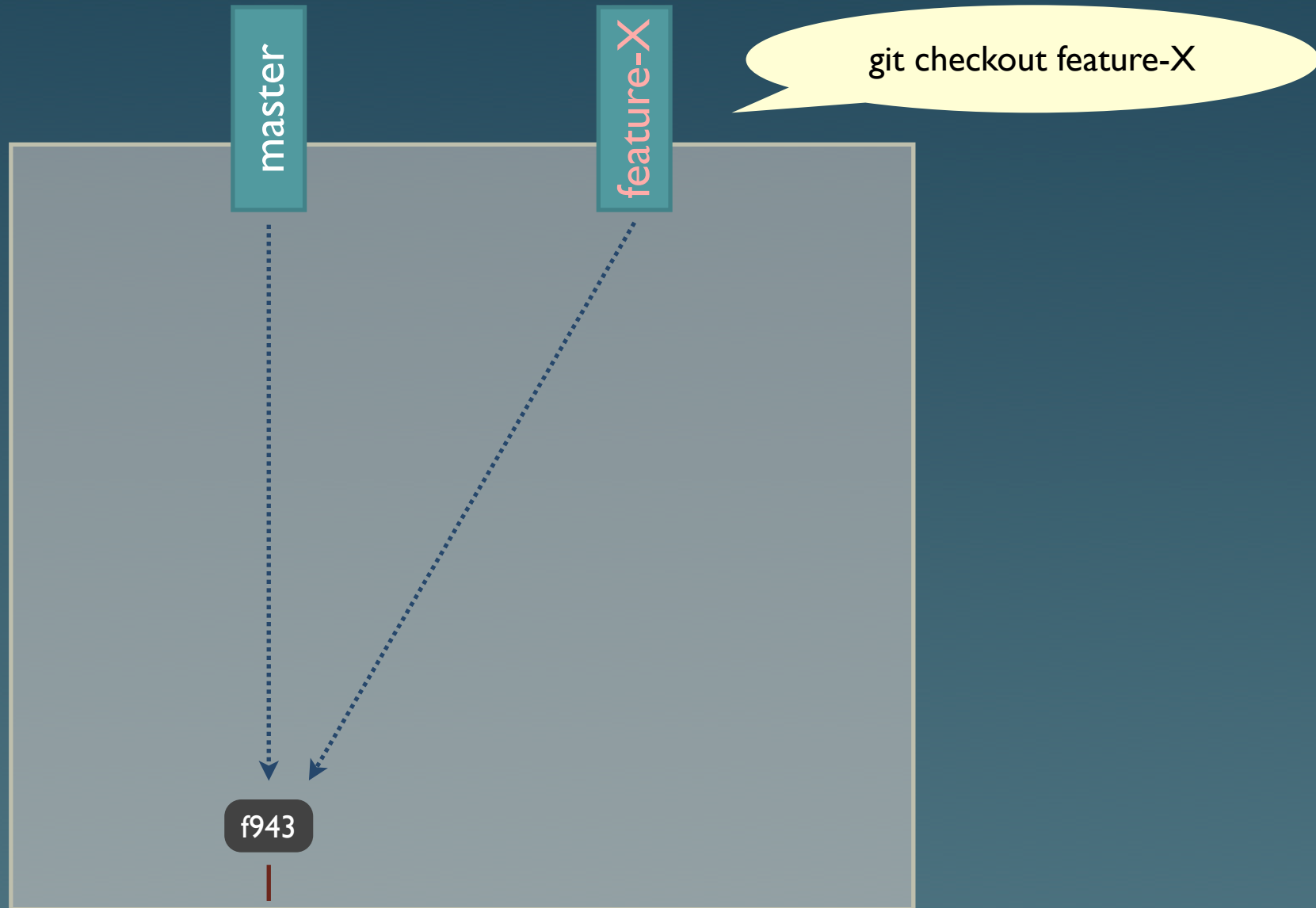

Git branches

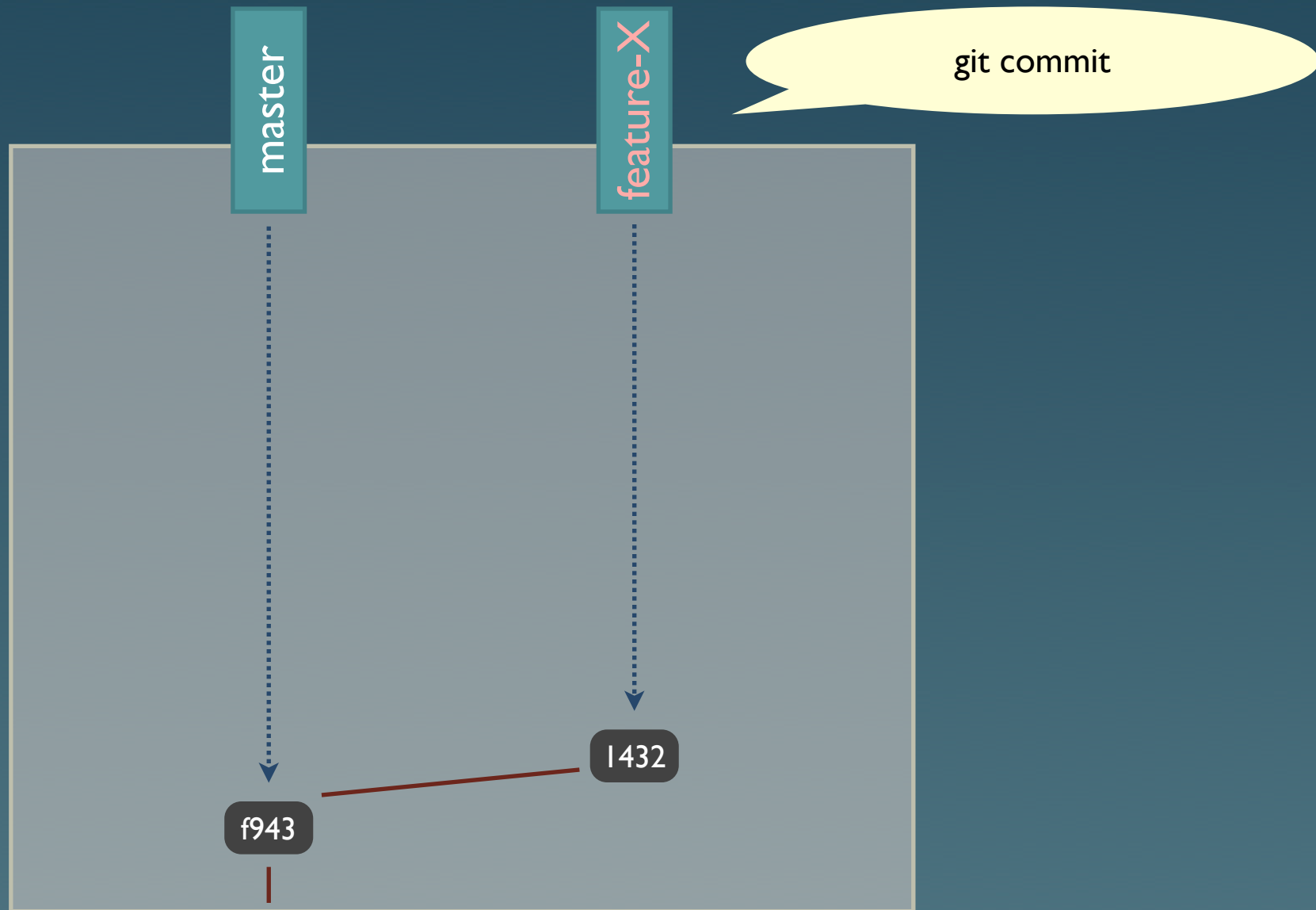

Git branches

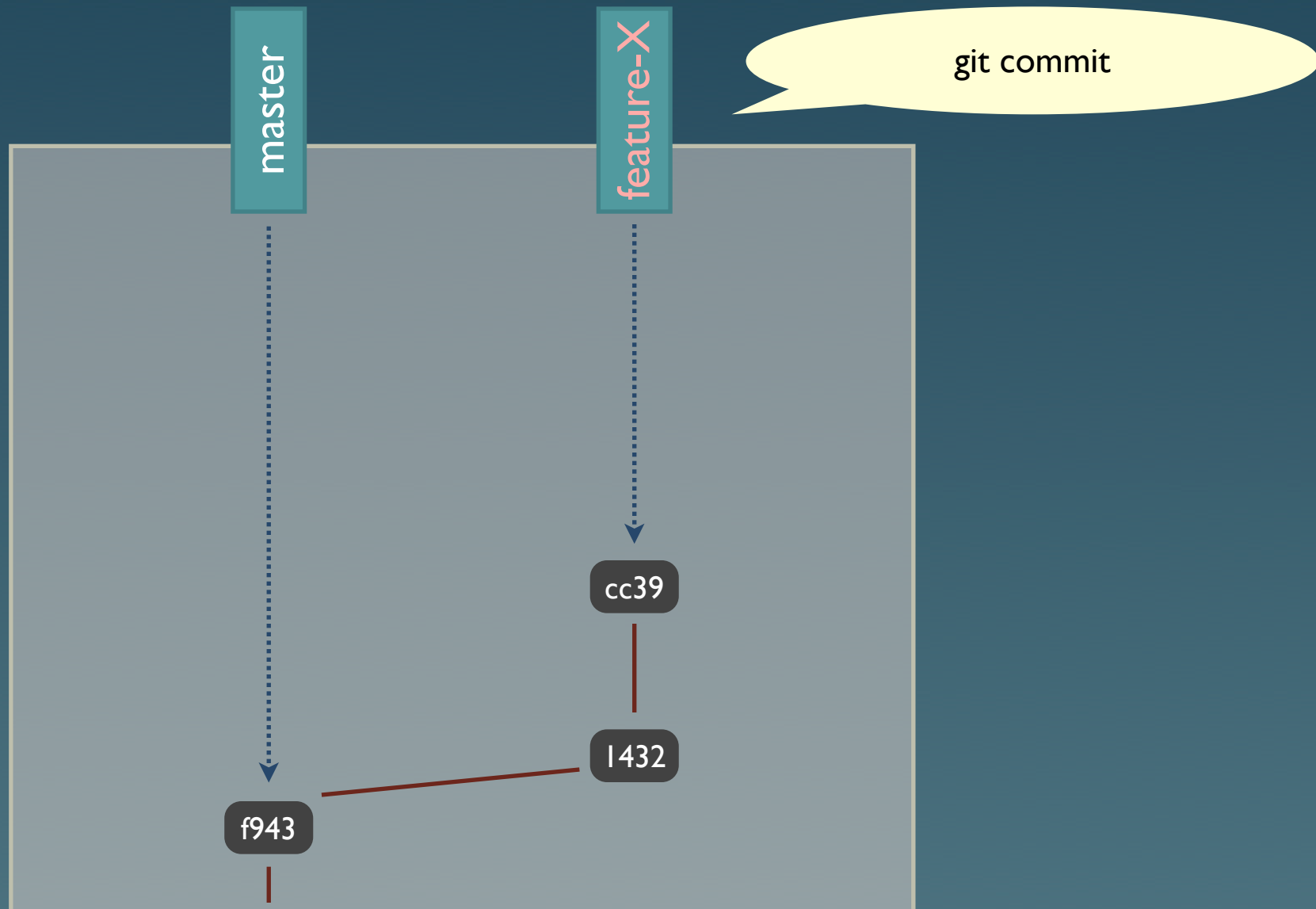

Git branches

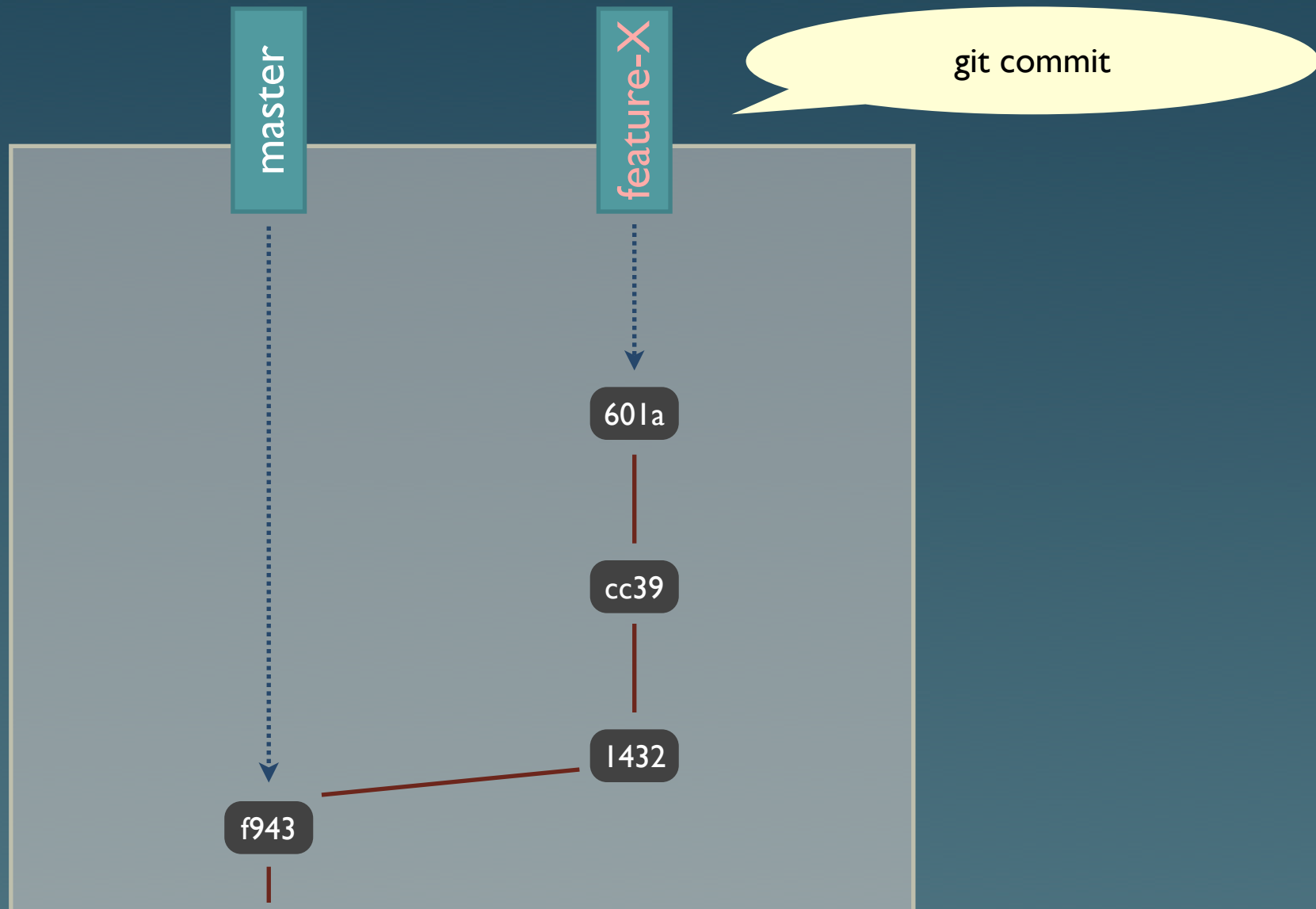

Git branches

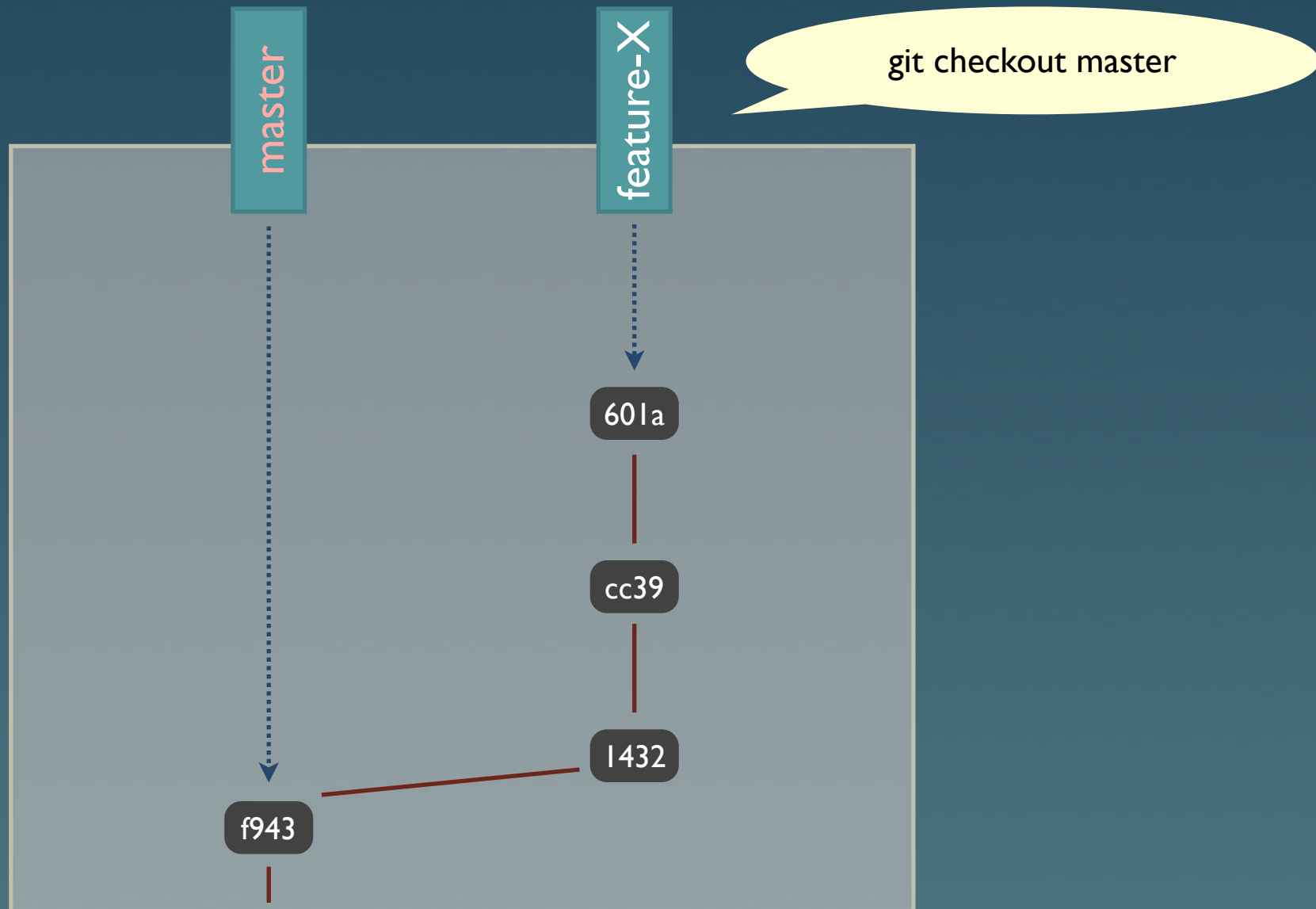

Git branches

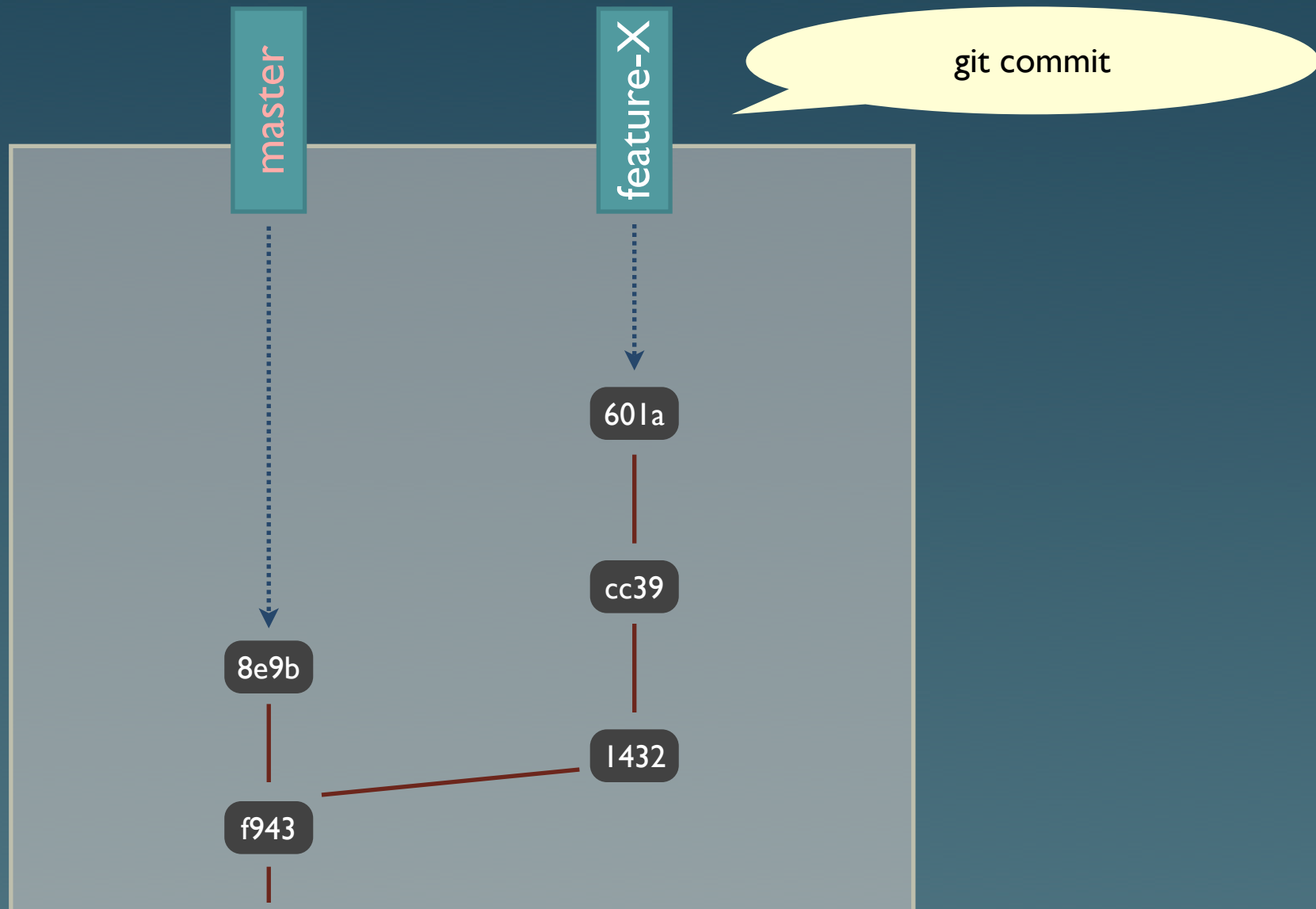

Git branches

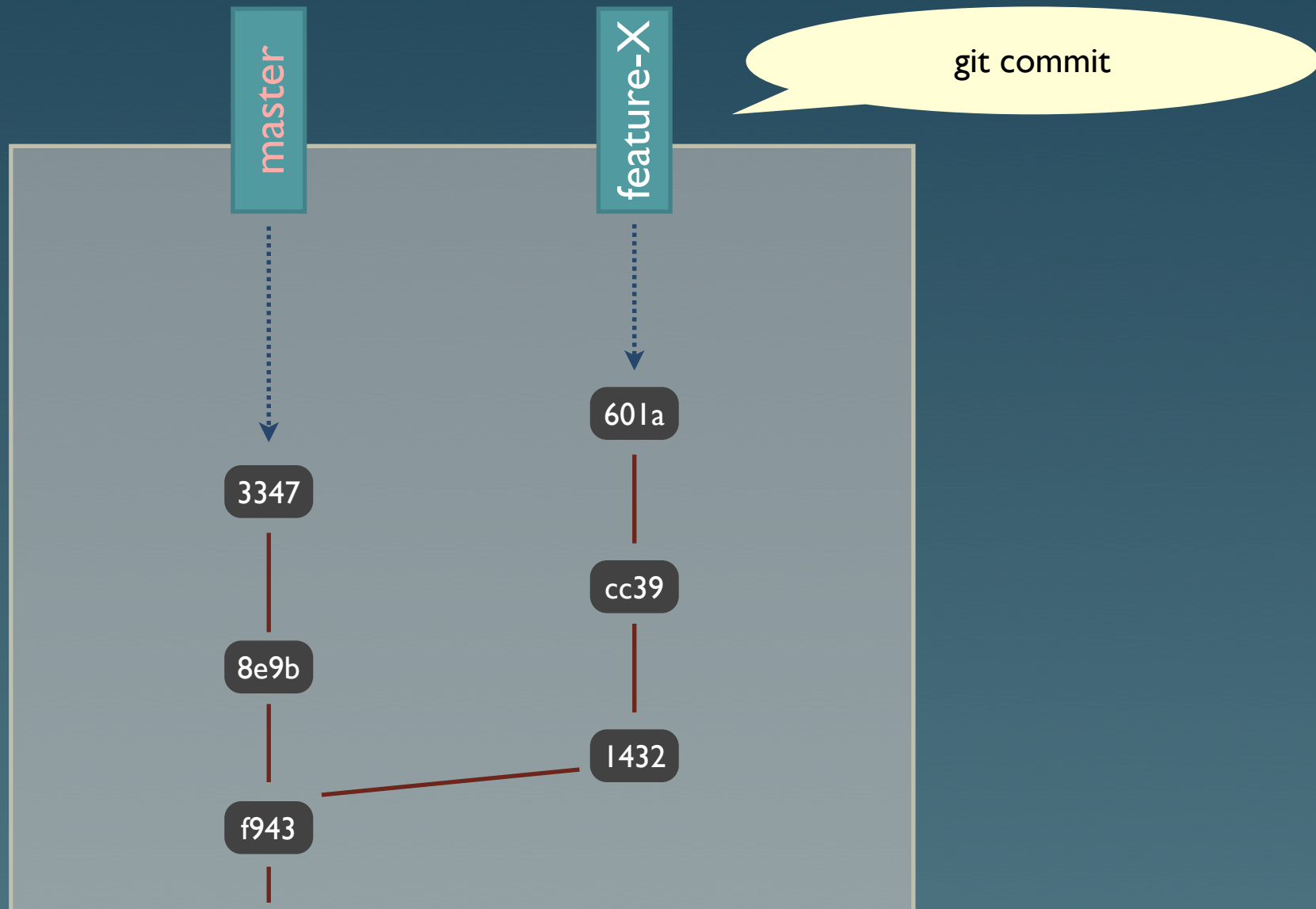

Git branches

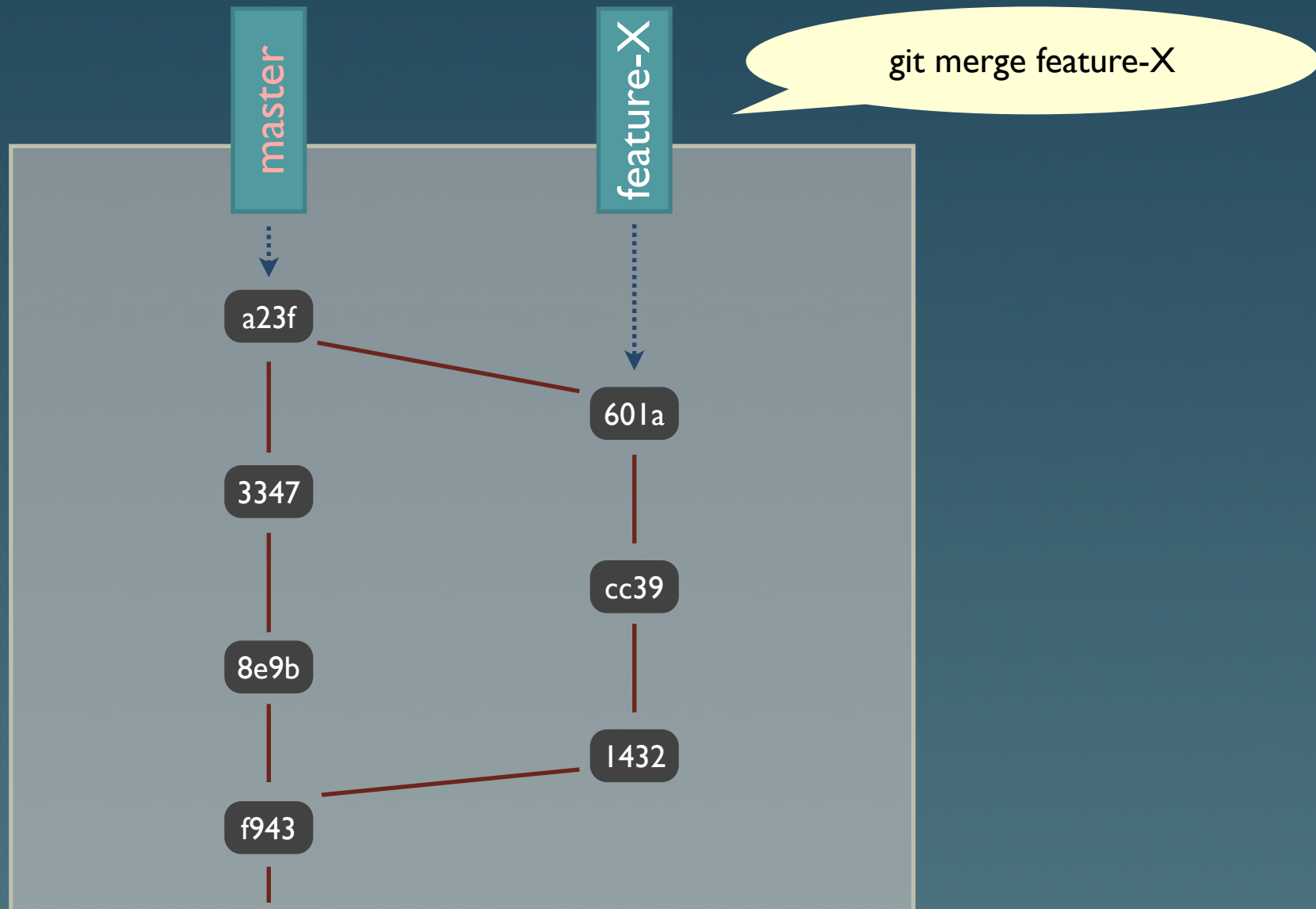

git show-branch

```
seb@faukes ~/Build/xmms2-devel $ git show-branch service-clients theefer sqlcrap
! [service-clients] PENDING REVIEW, INCOMPLETE
* [theefer] OTHER: Fix leaks with coll_read_collname.
! [sqlcrap] BEWARE! EXPERIMENTAL! Modified database schema to use integers for keys. BACKUP MEDIALIB!
---
* [theefer] OTHER: Fix leaks with coll_read_collname.
* [theefer^] BUG(1907): Allow 'All Media' as pshuffle input.
* [theefer^2] BUG(1095): Make xmms2d handle -h.
* [theefer^3] BUG(1904): Fix crash in volume setting/getting in pulseaudio plugin.
* [theefer^4] OTHER: Added PGP fingerprint for Sebastian Noack (wallunit).
* [theefer^5] OTHER: Updated my PGP key fingerprint
* [theefer^6] OTHER: Another try on implementing perl constant mapping.
* [theefer^7] OTHER: Fix some compilation warnings in the perl bindings.
* [theefer^8] BUG(1896): Made the config object use a BST instead of a hashtable.
+ [sqlcrap] BEWARE! EXPERIMENTAL! Modified database schema to use integers for keys. BACKUP MEDIALIB!
+ [sqlcrap^] OTHER: Make sources two way hashable.
** [theefer^9] OTHER: Remove old unused visualisation
** [theefer^10] OTHER: Cache result of "get next medialib id" in xmms_medialib_session_t
** [theefer^11] FEATURE(1470): Add xmmsc_playlist_add_idlist and make cli's addpls use it.
** [theefer^12] BUG(1805): Add xform_media_browse_encoded to pythonbindings.
** [theefer^13] BUG(1822): Properly emit entry_added broadcasts when using the radd command.
** [theefer^14] BUG(1893): Fix handling of playlists to "xmms2 add" cli command.
** [theefer^15] BUG(1875): Fix leak in cue plugin.
** [theefer^16] OTHER: cleanup xmmsclient-glib
** [theefer^17] BUG(1861): copy startup scripts instead of doing nothing when the os doesn't support symlinks
** [theefer^18] OTHER: disable ET on win32
** [theefer^19] BUG(1873): don't try to install objects in pixmaps
** [theefer^20] OTHER: log error when a script fails to run
+ [service-clients] PENDING REVIEW, INCOMPLETE
+ [service-clients^] OTHER: Add service id to the result of service method changed broadcast.
+ [service-clients^2] OTHER: Add other service broadcasts and related functions in clientlib.
+ [service-clients^3] OTHER: Ignore Emacs temp file.
```

gitk

The screenshot shows the gitk interface for a repository named 'xms2-devel'. The top menu bar includes 'File', 'Edit', 'View', and 'Help'. The main window is divided into three panes:

- Left Pane (Commit History Tree):** Displays a tree of commits. The current commit is 'service-clients' (SHA1: 931925a66df66ee6ea05be6c388abe5d76564f60). Other visible branches include 'remotes/theefer/master', 'remotes/anders/master', 'remotes/nesciens/master', 'remotes/nesciens/sqlexperimental2', 'remotes/nesciens/sqlexperimental1', and 'remotes/origin/master'. The tree shows a complex branching structure with multiple merges.
- Middle Pane (Commit List):** Lists the commit messages and their authors/committers with timestamps. The most recent commit is 'OTHER: Add service id to the result of service method cha' by Ning Shi on 2007-07-02. Other notable commits include 'BUG(1896): Made the config object use a BST instead of a h...' by Anders Waldenborg and 'OTHER: Update waf to 1.3.2.' by Anders Waldenborg.
- Right Pane (Diff View):** Shows the diff for the selected commit. It includes a 'Comments' section listing files: 'src/clients/cli/cmd_coll.c', 'src/clients/cli/cmd_pls.c', and 'src/clients/cli/common.c'. Below this, there are tabs for 'Diff', 'Old version', and 'New version lines of content'. The diff content is currently empty.

At the bottom, there are several controls: a 'SHA1 ID' field with the current commit's ID, navigation arrows, a 'Find' button, and a search bar. Below the search bar are buttons for 'Patch' and 'Tree'.

gitk

The screenshot shows the gitk graphical user interface. At the top, the window title is "code gitk: xmms2-devel" and the page number is "1/2". The main area is divided into three columns: a commit history graph on the left, a list of commit messages in the middle, and a list of commit authors and dates on the right. The graph shows a main branch (blue) and several other branches (green, red, pink, orange) that have merged back into the main branch. The commit messages include various updates to DEBIAN files, package dependencies, and version numbers. The authors listed are Anders Waldenborg and Florian Ragwitz. Below the main area, there is a "SHA1 ID:" field with the value "931925a66df66ee6ea05be6c388abe5d76564f60", a "Find" button, and a "Highlight:" section with "Commits" selected. At the bottom, there is a "Search" field and a "Diff" section showing the changes in the selected commit, including the author, committer, parent, child, branches, follows, and precedes information. The diff shows changes to files in the "src/clients/cli/" directory.

code gitk: xmms2-devel 1/2

File Edit View Help

DEBIAN: Remove builddir for all pythonversions in clean ta	Anders Waldenborg <anders@debian.org>	2008-01-27 19:43:06
DEBIAN: Change/update some dependencies.	Anders Waldenborg <anders@debian.org>	2008-01-27 19:42:44
DEBIAN: Clean up some rules dependencies.	Florian Ragwitz <rafl@debian.org>	2007-11-16 10:10:34
DEBIAN: Fix the version number.	Florian Ragwitz <rafl@debian.org>	2007-11-16 09:24:25
DEBIAN: Changelogging for DrKosmos.	Florian Ragwitz <rafl@debian.org>	2007-11-16 09:05:12
Merge commit '0.4DrKosmos' into debian	Florian Ragwitz <rafl@debian.org>	2007-11-16 08:58:59
DEBIAN: Update version number.	Florian Ragwitz <rafl@debian.org>	2007-11-15 07:57:28
Merge branch 'master' into debian	Florian Ragwitz <rafl@debian.org>	2007-11-15 07:57:02
DEBIAN: Build the python module for both 2.4 and 2.5	Florian Ragwitz <rafl@debian.org>	2007-11-15 07:51:21
DEBIAN: Don't pass install twice to waf.	Florian Ragwitz <rafl@debian.org>	2007-11-13 15:50:45
Merge branch 'master' into debian	Florian Ragwitz <rafl@debian.org>	2007-11-13 15:23:06
DEBIAN: Package the pulse plugin.	Florian Ragwitz <rafl@debian.org>	2007-11-13 13:43:32
DEBIAN: Adjust debian/rules to the new SONAMES.	Florian Ragwitz <rafl@debian.org>	2007-11-13 13:29:03
Merge commit 'anders/master' into debian	Florian Ragwitz <rafl@debian.org>	2007-11-13 13:20:46
DEBIAN: changelogging.	Florian Ragwitz <rafl@debian.org>	2007-11-13 13:19:27
DEBIAN: Update package names to reflect SONAMES.	Florian Ragwitz <rafl@debian.org>	2007-11-13 13:17:16
Merge branch 'master' into debian	Florian Ragwitz <rafl@debian.org>	2007-11-13 12:52:33
DEBIAN: Fix debian/NEWS syntax.	Florian Ragwitz <rafl@debian.org>	2007-11-13 12:19:42
DEBIAN: Add packages for the normalize plugin.	Florian Ragwitz <rafl@debian.org>	2007-11-13 12:17:02
DEBIAN: Add packages for the asf plugin.	Florian Ragwitz <rafl@debian.org>	2007-11-13 12:07:13
DEBIAN: Install the pixmaps into xmms2-core.	Florian Ragwitz <rafl@debian.org>	2007-11-13 12:03:00
DEBIAN: Call waf with --nocache.	Florian Ragwitz <rafl@debian.org>	2007-11-13 11:55:40
DEBIAN: Remove obsolete patches.	Florian Ragwitz <rafl@debian.org>	2007-11-13 11:51:34

SHA1 ID: 931925a66df66ee6ea05be6c388abe5d76564f60 Find

Highlight: **Commits** touching paths: OR in view **None** OR

Patch Tree

Diff Old version New version lines of content

Author: Sebastien Cevey <seb@cine7.com>
Committer: Sebastien Cevey <seb@cine7.com>
Parent: [9cf45f636caa89591ded058544](#)
Child: [00000000000000000000000000000000](#)
Branches: [remotes/theefer/master](#),
Follows: [0.4DrKosmos](#)
Precedes:

Comments
src/clients/cli/cmd_coll.c
src/clients/cli/cmd_pls.c
src/clients/cli/common.c

Distribué

Repo. public du dev.

Repo. local du dev.

Repo. local de l'utilisateur

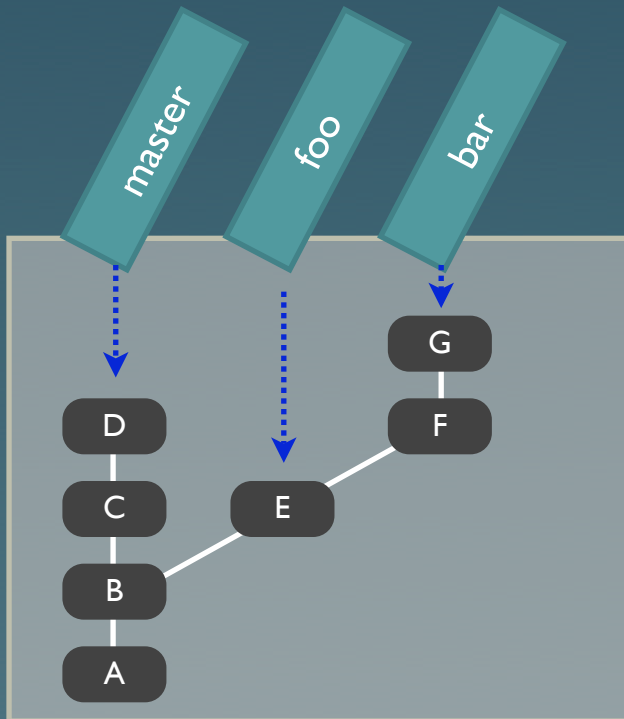

Distribué

push
(par ssh://, git://, rsync://, etc)

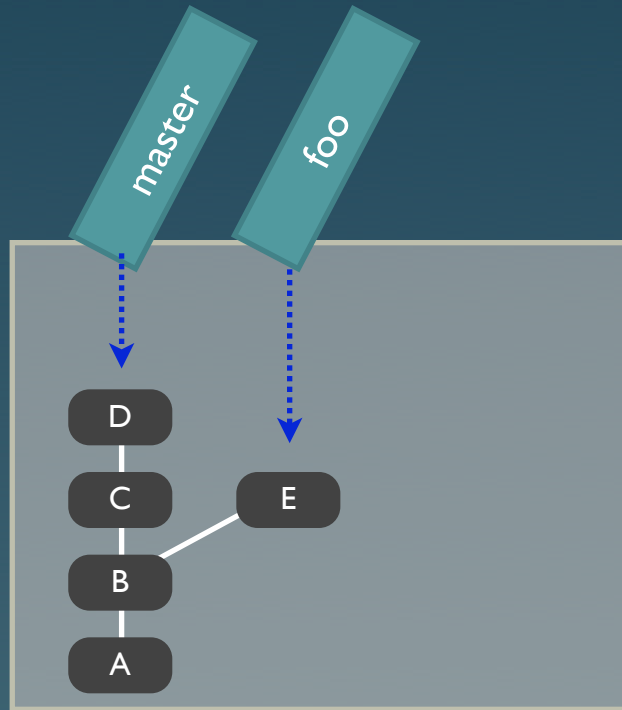
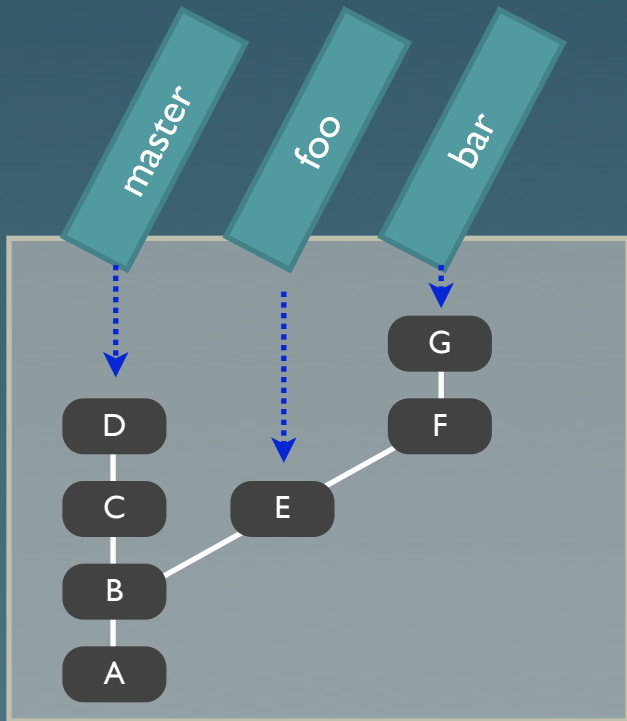

Distribué

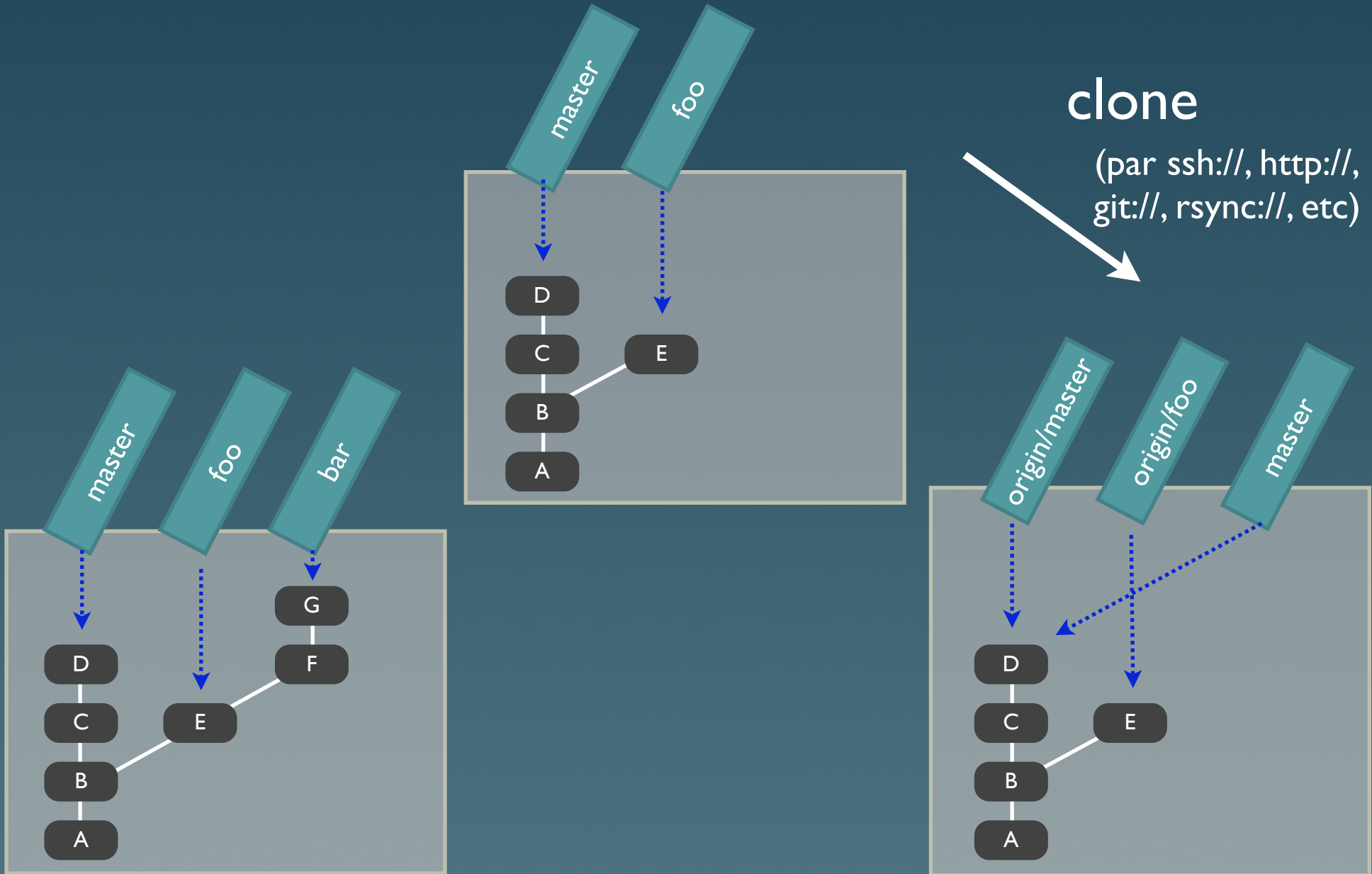

Distribué

commit!

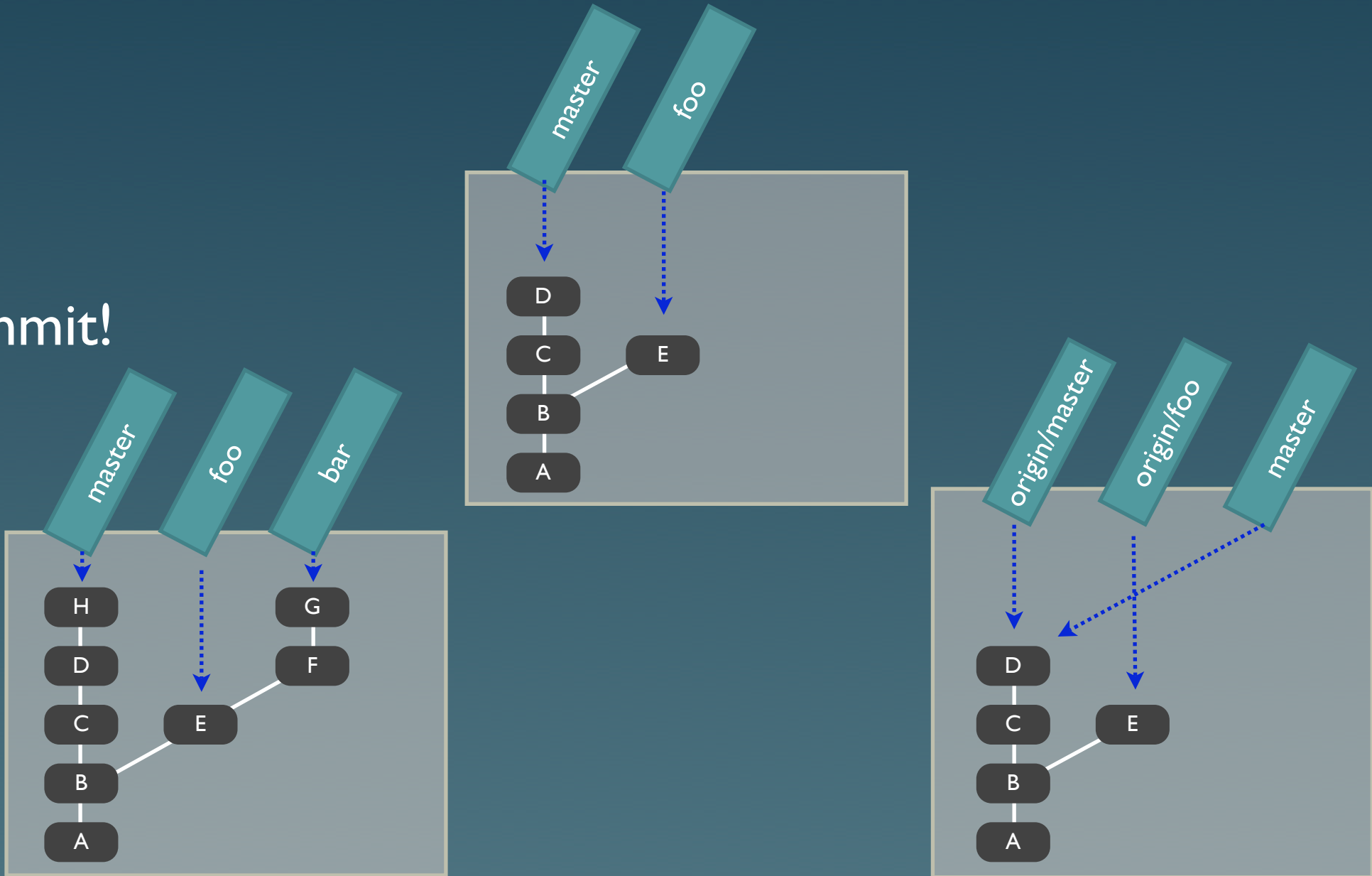

Distribué

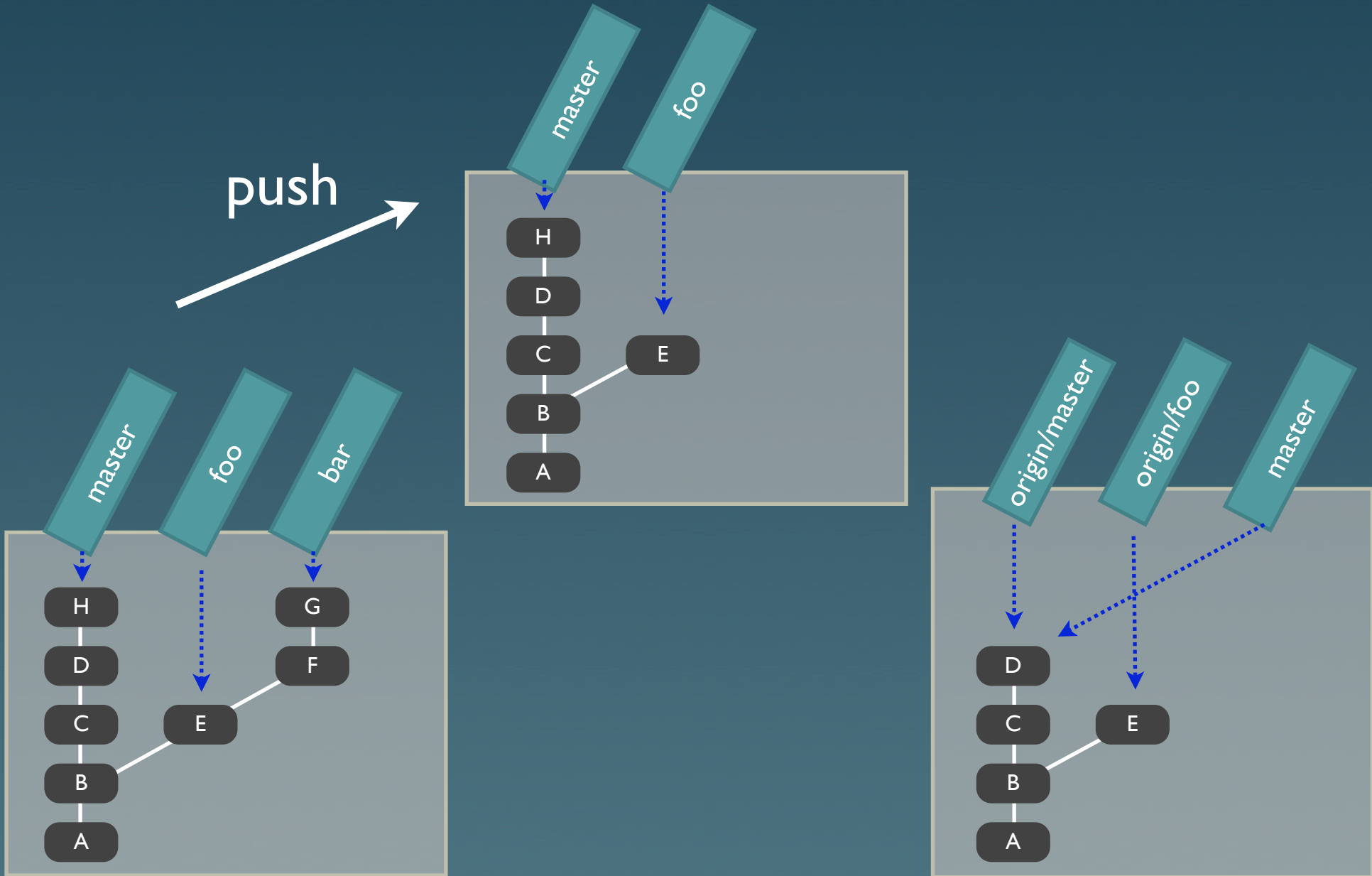

Distribué

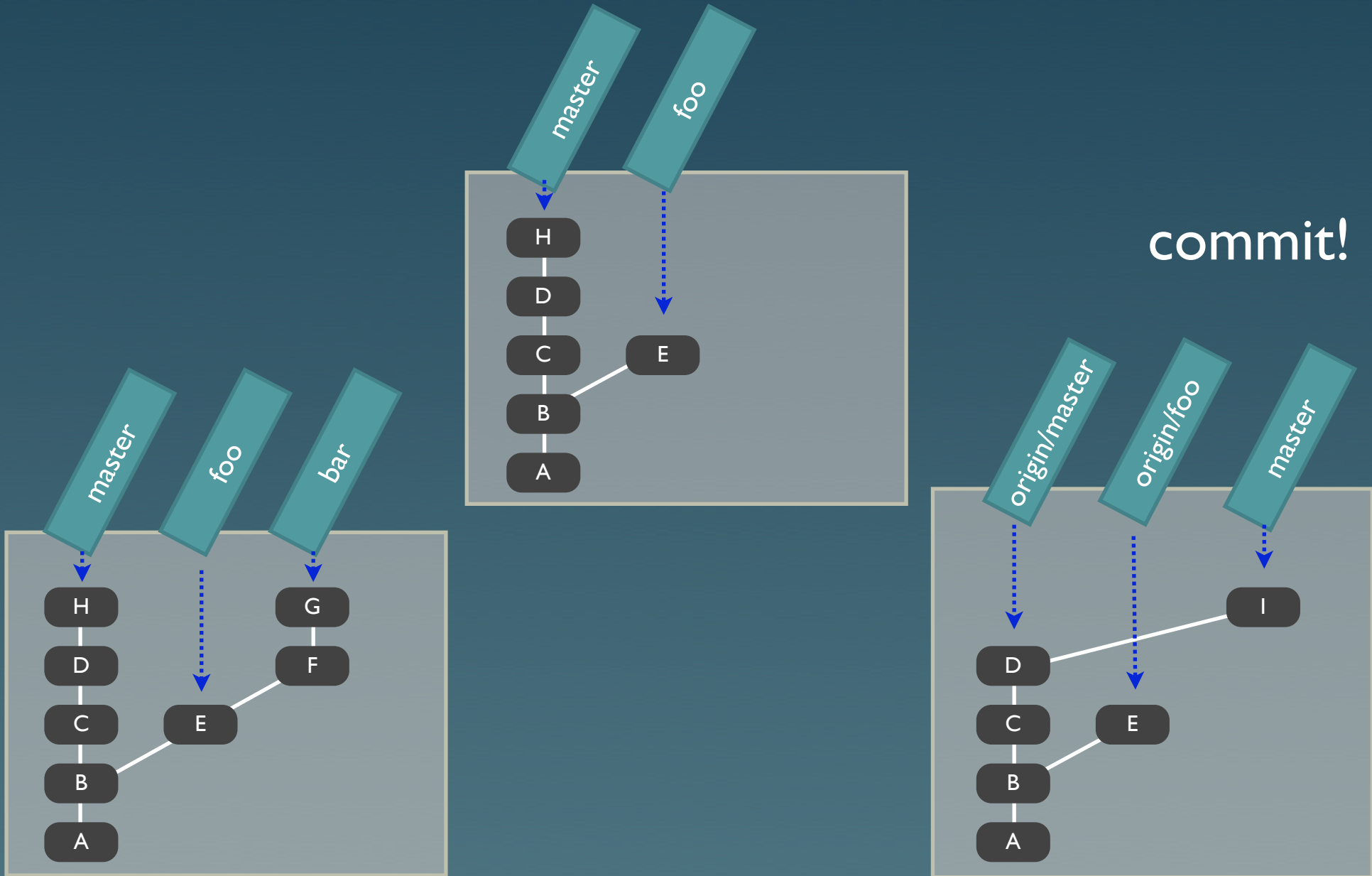

Distribué

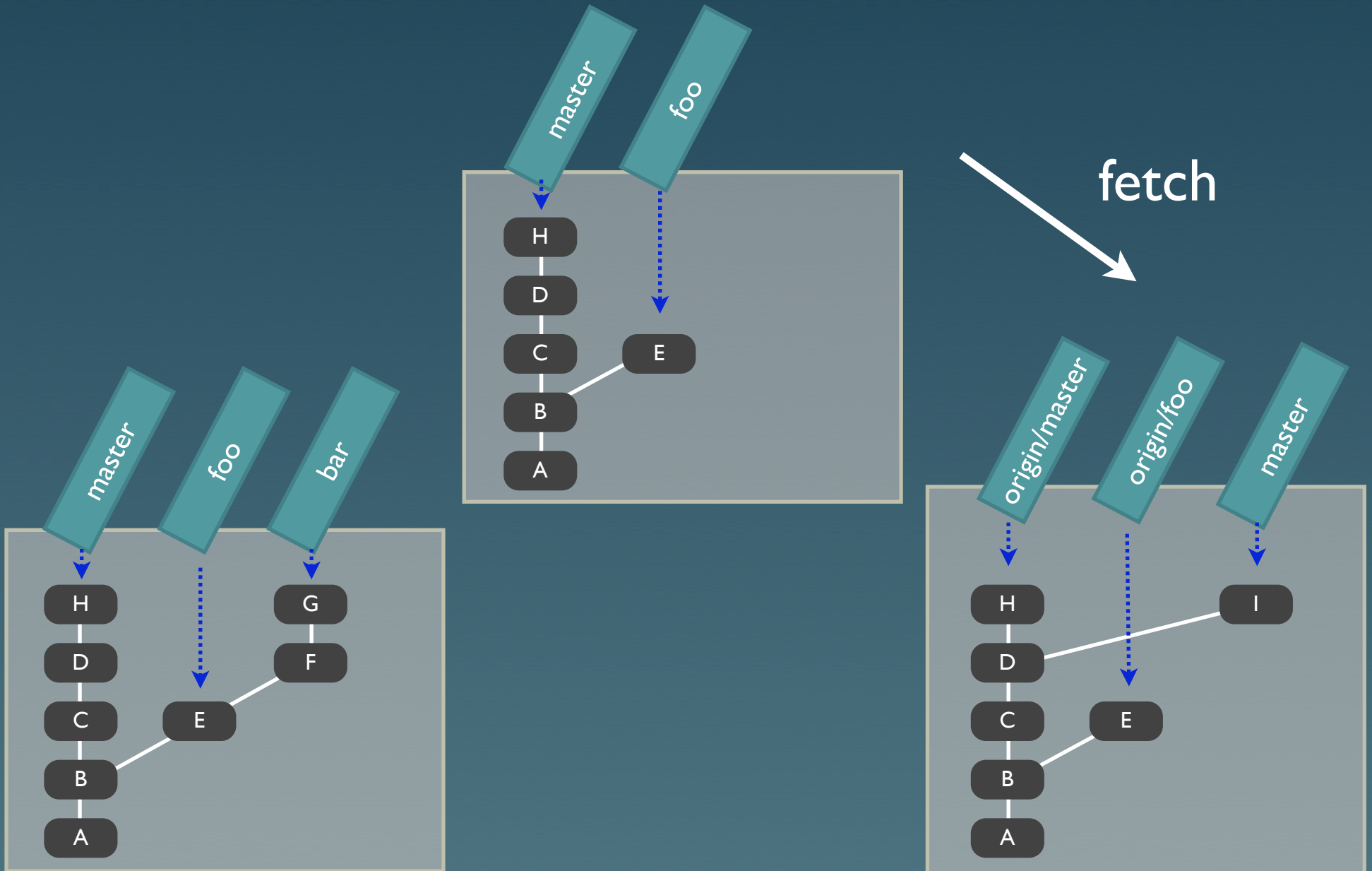

Distribué

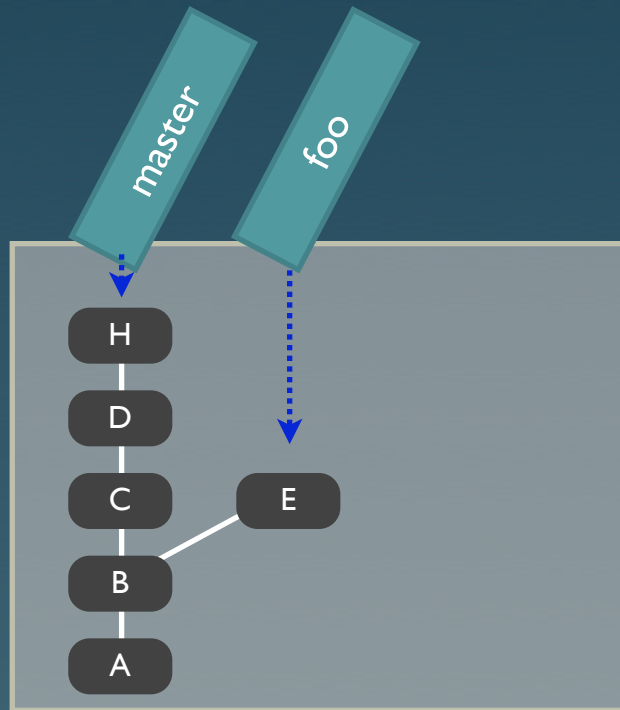
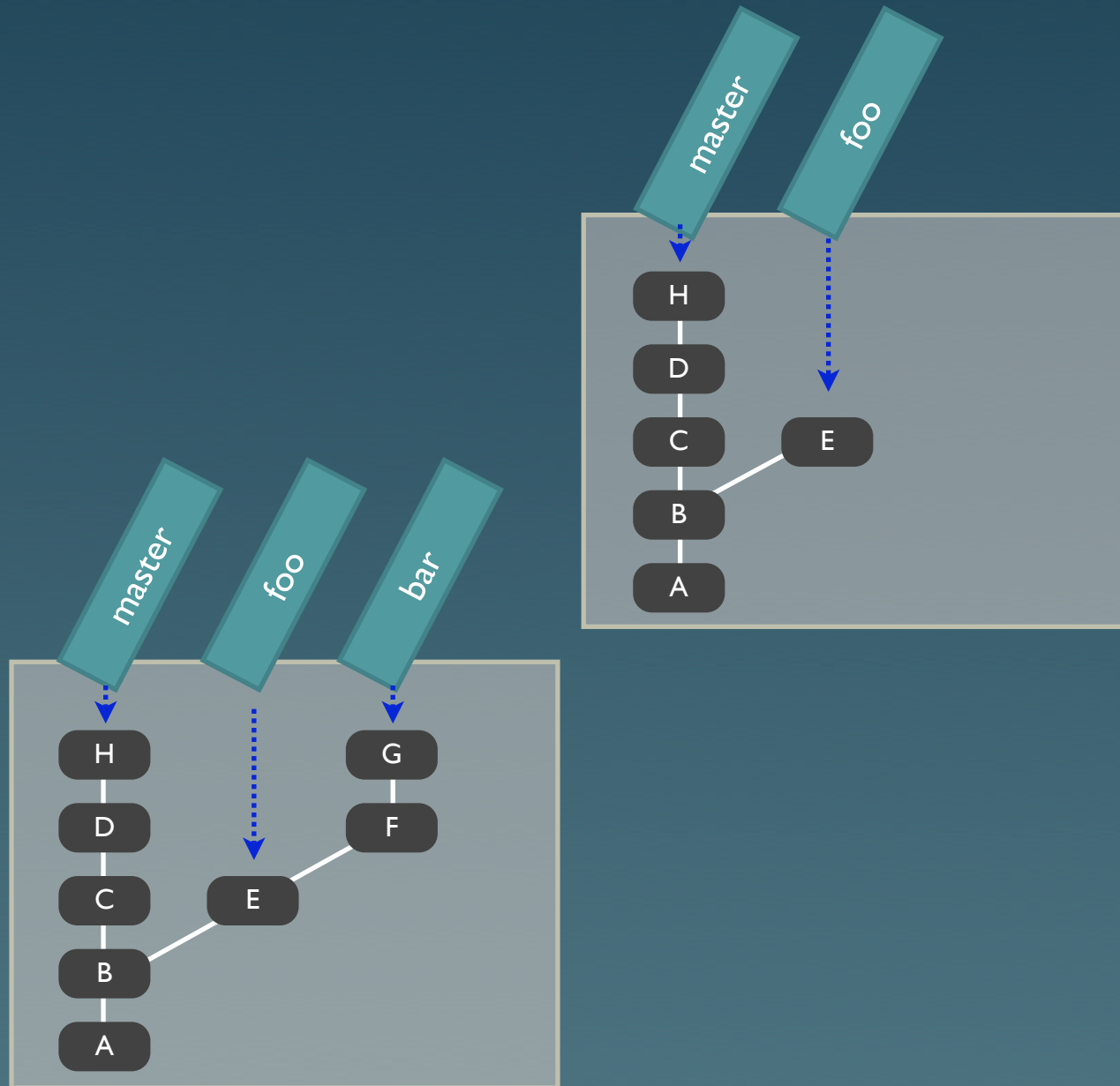

Solution 1: **merge**

(crée un nouveau
commit de merge)

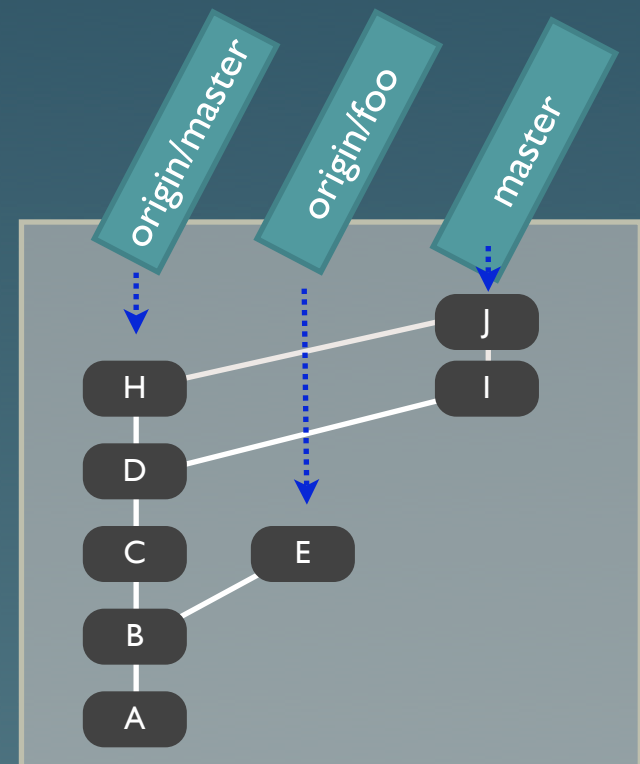

Distribué

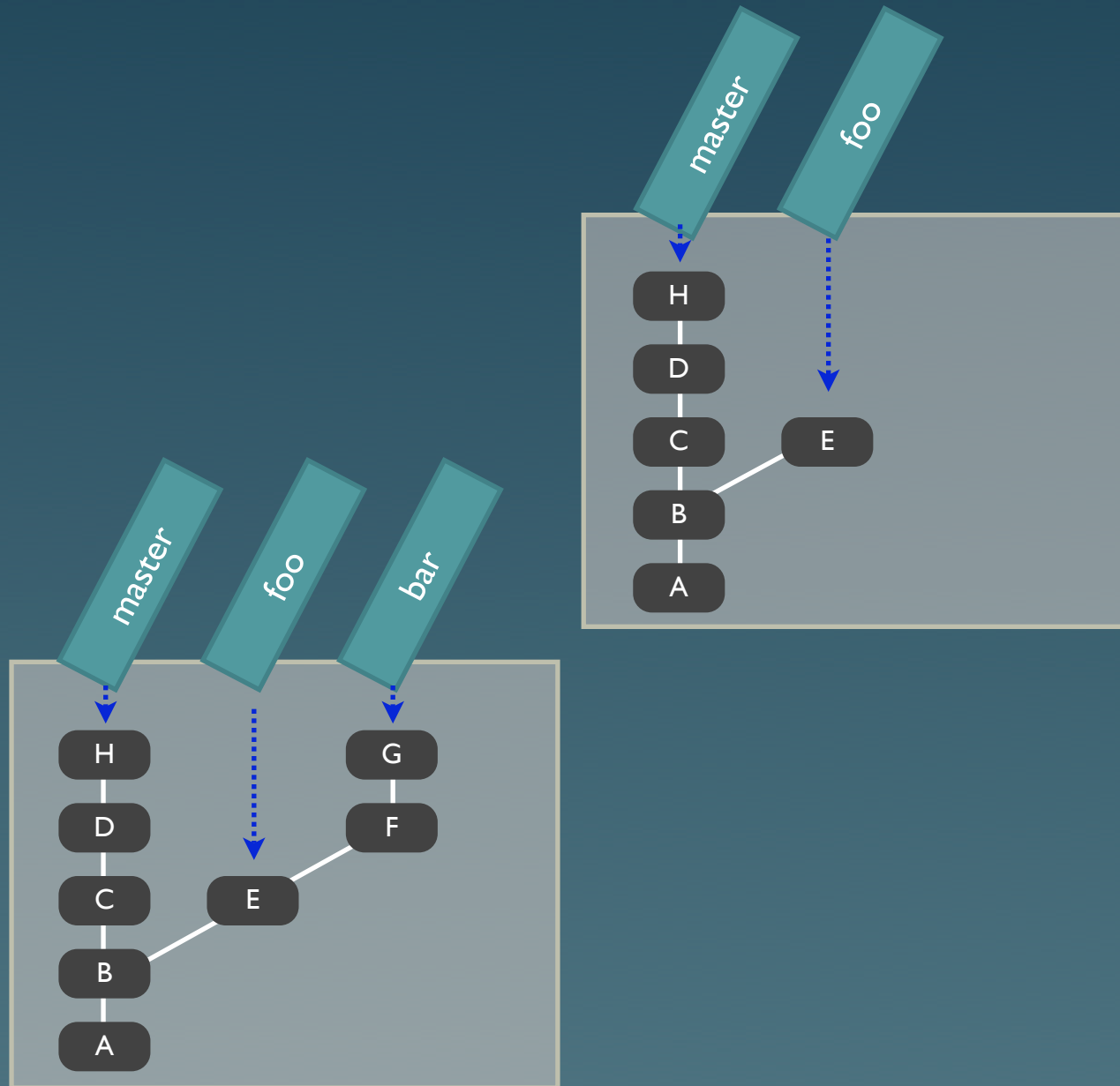

Solution 2: **rebase**

(plus propre pour
envoyer des patches)

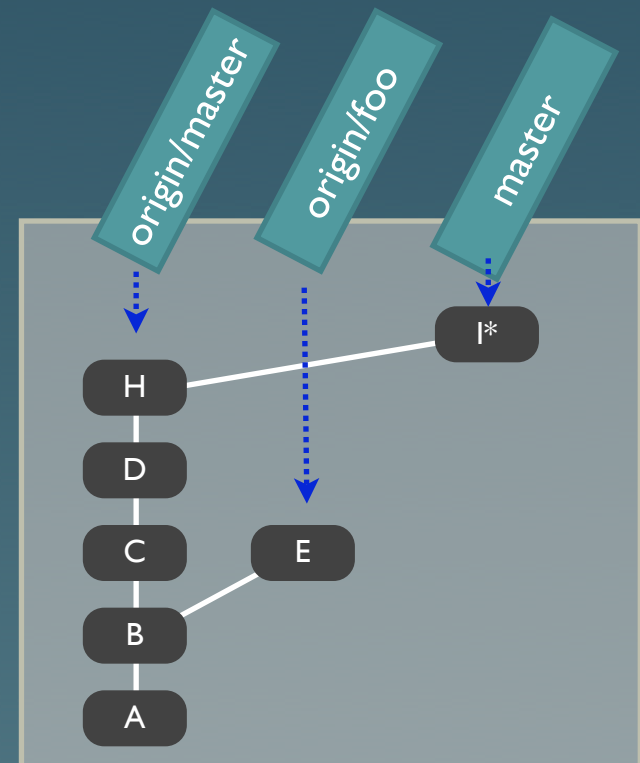

Distribué

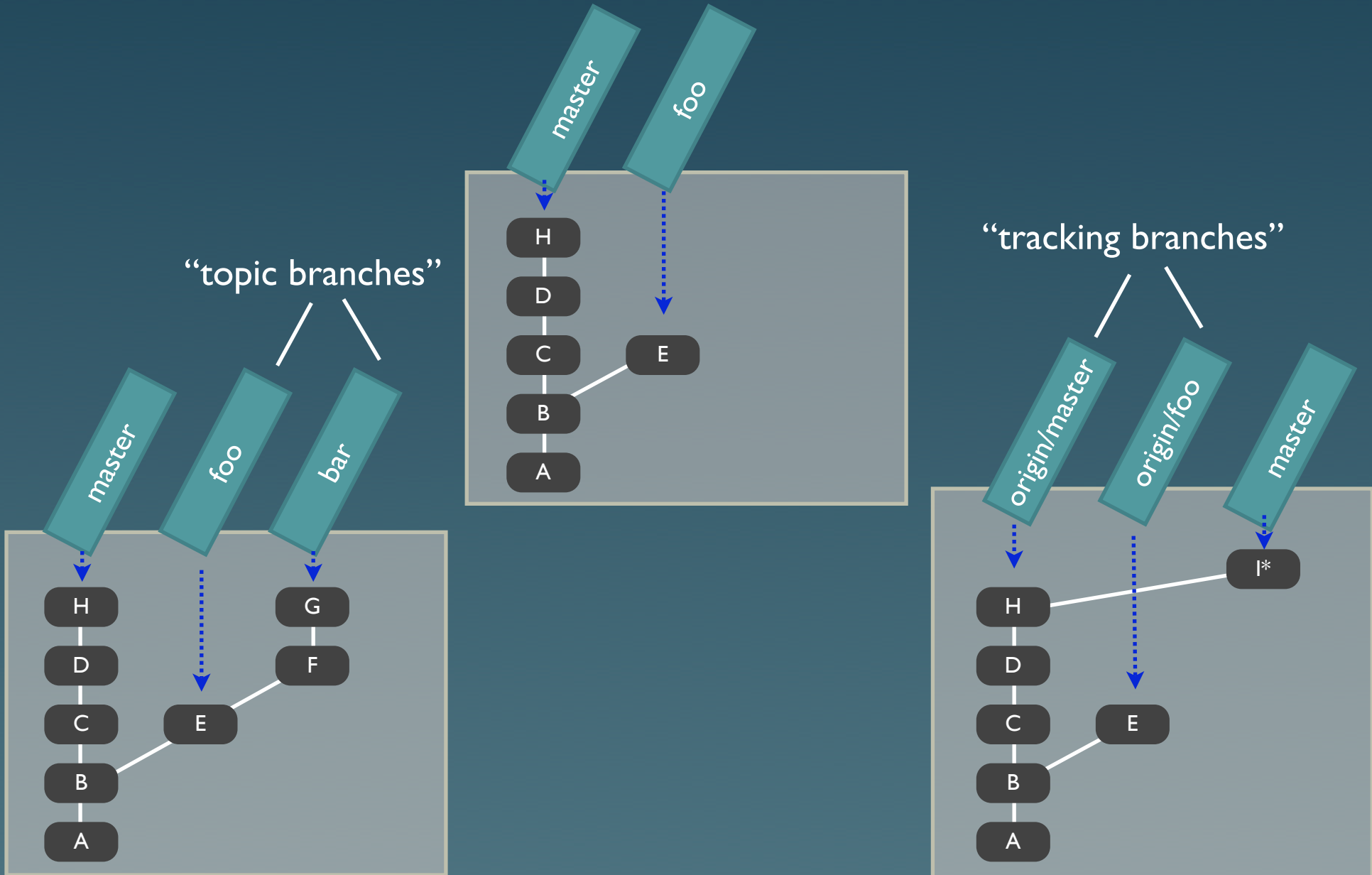

Et encore...

- Fonctionnalités avancées:
Index, shallow copies, stash, submodules, bundles, etc.
- Utilitaires:
Gitweb, git-daemon, etc.

gitweb

web | git - xmms2-devel.git/summary - Mozilla Firefox ~1/1

http://git.xmms.se/?p=xmms2-devel.git;a=sum Google

projects / xmms2-devel.git / summary

summary | [shortlog](#) | [log](#) | [commit](#) | [commitdiff](#) | [tree](#) | [latest snapshot](#)

description XMMS2 Development tree.
owner Tobias Rundström
last change Wed, 5 Mar 2008 17:57:47 +0000
url [git://git.xmms.se/xmms2/xmms2-devel.git](http://git.xmms.se/xmms2/xmms2-devel.git)

shortlog

2 days ago	Erik Massop	OTHER: Fix a warning introduced in 01c0fceed53e6ead28fd ...	commit commitdiff snapshot
2 days ago	Erik Massop	BUG(1909): Absolute paths in playlistfiles malfunction	commit commitdiff snapshot
2 days ago	Erik Massop	BUG(1902): Allow for case-sensitive MATCH and make ...	commit commitdiff snapshot
2 days ago	Anders Waldenborg	BUG(1095): Do not require glib 2.14, but use it if ...	commit commitdiff snapshot
3 days ago	Sebastien Cevey	OTHER: Fix leaks with coll_read_collname.	commit commitdiff snapshot
3 days ago	Sebastien Cevey	BUG(1907): Allow 'All Media' as pshuffle input.	commit commitdiff snapshot
7 days ago	Erik Massop	BUG(1095): Make xmms2d handle -h.	commit commitdiff snapshot
7 days ago	Anders Waldenborg	BUG(1904): Fix crash in volume setting/getting in pulse ...	commit commitdiff snapshot
9 days ago	Sebastian Noack	OTHER: Added PGP fingerprint for Sebastian Noack (wallu ...	commit commitdiff snapshot
9 days ago	Tobias Rundstrom	OTHER: Updated my PGP key fingerprint	commit commitdiff snapshot
9 days ago	Florian Ragwitz	OTHER: Another try on implementing perl constant mapping.	commit commitdiff snapshot
9 days ago	Florian Ragwitz	OTHER: Fix some compilation warnings in the perl bindings.	commit commitdiff snapshot
12 days ago	Tilman Sauerbeck	BUG(1896): Made the config object use a BST instead ...	commit commitdiff snapshot
13 days ago	Anders Waldenborg	OTHER: Remove old unused visualisation	commit commitdiff snapshot
2 weeks ago	Anders Waldenborg	OTHER: Cache result of "get next medialib id" in xmms ...	commit commitdiff snapshot
2 weeks ago	Erik Massop	FEATURE(1470): Add xmmsc_playlist_add_idlist and make ...	commit commitdiff snapshot

...

tags

3 months ago	0.4DrKosmos	0.4 DrKosmos Release	tag commit shortlog log snapshot
3 months ago	DrJekyll+WIP+TEST2	DrJekyll+WIP+TEST2 Release	tag commit shortlog log snapshot
3 months ago	DrJekyll+WIP+TEST1	DrJekyll+WIP+TEST1 Release	tag commit shortlog log snapshot
9 months ago	0.2DrJekyll	0.2 DrJekyll Release	tag commit shortlog log snapshot
9 months ago	DrJ+WIP+TEST5	DrJ+WIP+TEST5 Release	tag commit shortlog log snapshot

Conclusion

- Approche différente au versionnement
- Workflow souple et fluide
- Puissance vs. Courbe d'apprentissage

Questions?

<http://git.or.cz/>